

192

THE ONLY CANOE BOOK
YOU'LL EVER NEED

THE COMPLETE BOOK OF
CANOEING



THIRD EDITION

I. HERBERT GORDON

03092914

\$ 1.99

*To the memory of Frank Jones,
whose passionate belief that livery canoeing
should be a safe as well as rewarding activity
helped set standards for the National Paddlesports
Association that have made that belief a reality,
and to Scott, Hilary, Rebecca, Michelle, and Raegan.*

Copyright © 1992, 1997, 2001 by I. Herbert Gordon

All rights reserved. No part of this book may be reproduced or transmitted in any form by any means, electronic or mechanical, including photocopying and recording, or by any information storage and retrieval system, except as may be expressly permitted by the 1976 Copyright Act or by the publisher. Requests for permission should be made in writing to The Globe Pequot Press, P.O. Box 480, Guilford, CT 06437.

Cover photo copyright © Index Stock
Interior photos copyright © I. Herbert Gordon
Interior text design by Lisa Reneson

Charts on recommended quantities from *Food for Knapsackers and Other Trail Travellers* (page 175) by Hasse Bunnelle reprinted with permission of Sierra Club Books.

Library of Congress Cataloging-in-Publication Data

Gordon, I. Herbert.

The complete book of canoeing: the only canoeing book you'll ever need /
by I. Herbert Gordon.—3rd ed.

p. cm.

Includes index.

ISBN 0-7627-0900-6

1. Canoes and canoeing. I. Title.

GV783.G68 2001

797.1'22—dc21

2001023113

Manufactured in the United States of America
Third Edition/Second Printing

Basic Equipment

Canoes, Paddles, Life Vests, and Other Necessities

Some half a million people paddle the nation's waterways every week during the summer, most of them using equipment rented from the two-thousand or so liveries scattered throughout the country. The basics are few: canoe, paddles, life vests, sponge, painter (rope to tie onto the canoe), plastic bags for personal items, and whatever else a canoeist wants to bring along, from lunch to extra dry clothes. That's about it for the one-day pleasure cruise. Camping gear rounds out the list for overnight trips.

This chapter includes basic information that will acquaint novices with basic terminology and specific variations on equipment. Most canoeists rent their canoes, paddles, and life vests from responsible liveries and outfitters, but the chapter will educate you about what to expect when you arrive at the livery. You will learn about the parts and various types of canoes and paddles, life vest options, and other necessities for short and long trips. A section on accessories provides some ideas for extras that will make each trip easy and pleasurable.

If you are a beginner or novice, at least skim the chapter briefly so that you're familiar with the terms and can make a good decision when you are offered rental options. As you become more experienced, or if you are already familiar with the basics, read the chapter more thoroughly so that you feel comfortable requesting a specific variety when you rent for different kinds of trips. Eventually you may want to purchase your own equipment; at that point, review the chapter carefully to make sure you buy the right equipment for your favorite kind of canoeing.

Canoes

Whether you're a beginner about to try a day on a popular river with a group of friends, or a veteran paddler beginning to think about buying a sleek, sturdy canoe of your own, you should know something about canoes themselves.

The Parts of a Canoe

Figure 1 gives the correct names for the parts of a typical aluminum canoe. These are the same basic parts found on all canoes, no matter what they are made of.

In the old days of wood-and-canvas canoes, the bang plate on the better-quality crafts was a band of brass that protected the delicate and intricate front of the bow and, often, the stern. It is common today to see plastic canoes fitted with bang plates made of Kevlar, a material that looks much like fiberglass. A strip of Kevlar covers the bow and stern and extends a foot or two under the bottom of the craft. This reinforcement, popular on rental canoes, protects the bow against rocks and other objects that crop up to harass inexperienced paddlers. It also offers some protection to the forward bottom of the canoe, which inevitably gets scraped when being paddled onto the shore.

Note part 5, the gunnel. The part of the gunnel that faces the inside of the canoe is known as the inwale; the part facing the outside, the outwale. Also note the extended keel, a feature found mainly on aluminum and wood-canvas canoes.

The Shapes of Canoes

On the canoe shown in figures 2 and 3, notice that the sides slope inward toward the gunnel. This kind of slope, called a tumblehome, was developed long ago by Indians building birchbark canoes. It helps keep water from splashing into the craft.

The part of the outwale that extends out from the canoe also helps keep water from splashing up and into the canoe. Some designs will use a slight outward flare, instead of a tumblehome, to keep water out of the craft.

If there is a general, although not always reliable, rule about the sides flaring, forming a tumblehome, or going almost straight up from bilge to gunnel, it is this: The straight side is basically for touring; the other shapes give more protection on rougher river waters.

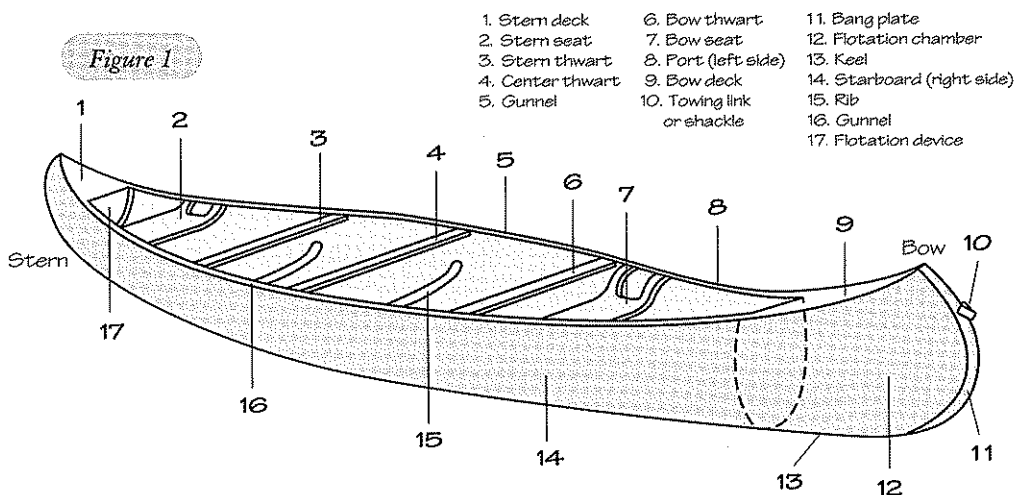

Like the sides of the craft, the bottoms vary in shape, as shown with some exaggeration in figure 4.

A flat bottom is a delight to the novice. It gives a canoe a feeling of stability. A flat-bottomed boat is also easier to maneuver in white-water. When a flat-bottomed canoe tilts sharply to one side, however, it is much more apt to flip over than a round-bottomed canoe. Therefore, though the round bottoms do not have the initial feeling of stability, they are more forgiving when tipped, thus providing more total stability.

There also are some subtle differences in hull shapes involving what are described by their designers as a shallow V and a shallow arch. The V-configuration canoes generally track (travel in a straight line) better, whereas canoes with the flatter and rounded bottoms maneuver better.

The "rocker" is the longitudinal curve of the canoe as illustrated in figure 5. The straighter the hull, the better it holds a straight course. The upswept ends are designed for greater maneuverability. Extreme curves are the choice of whitewater paddlers where swift maneuverability is required. Most canoes rented by liveries tend to have flat bottoms and a modest rocker or none at all.

Canoes differ in such areas as the depth measured from the gunnel to the bottom; the length measured from tip to tip, as well as along the waterline; and the beam, the width from gunnel to gunnel in the middle of the canoe.

The great variety of shapes have more meaning to the person planning to buy a canoe than to one renting a canoe. If you have a choice, though, choose a rental canoe that meets your specific needs, whether it is a solo canoe for whitewater work or a canoe that will paddle easily day after day on a wilderness trip that does not involve whitewater.

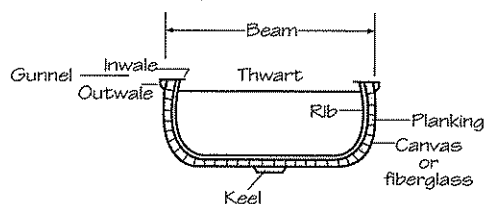

Figure 2

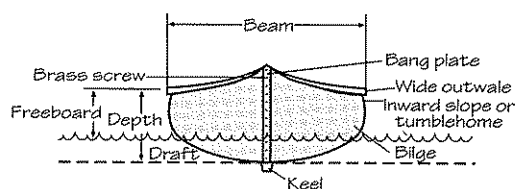

Figure 3

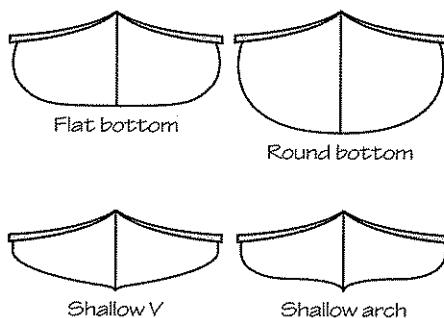

Figure 4

Longitudinal construction

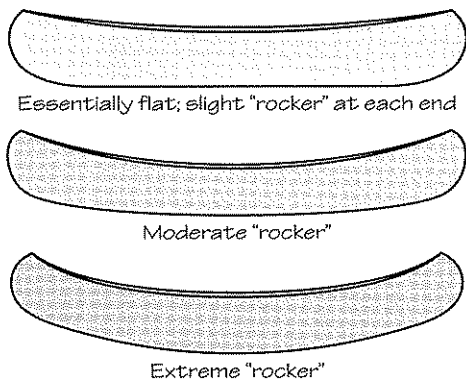
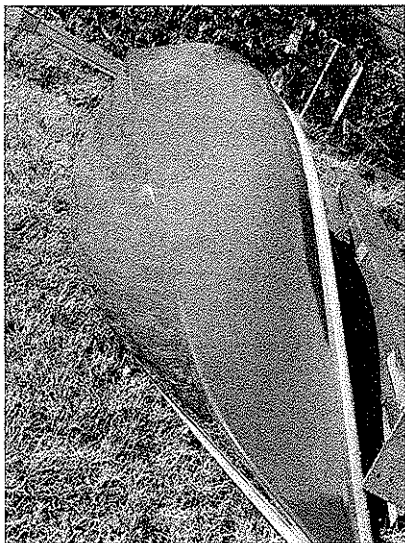

Figure 5



The slight V hull marks this as a touring canoe, especially suited for long travel on flat water. The V hull is slightly more difficult to maneuver than the flat hull.

Types of Canoes

Canoe & Kayak magazine classifies canoes into several types:

- The *casual recreation* canoe is best described as a canoe that “feels safe.” It is 16 to 17 feet long, with a flat bottom and a slight rocker, is easy to maintain and store, and performs moderately well on short cruising trips and in modest currents.

- A *touring* canoe is usually somewhat longer (from 16½ to 18 feet) and has a wider beam for higher volume, to hold camping equipment. With its somewhat rounded bottom, the touring canoe is good for flat-water work and maneuvers well in light rapids.

- The *weekender* is a medium-volume canoe, about 16 to 17½ feet long, that will easily handle a total load of around 600 to 700 pounds; it tends to be a bit quicker on the water than the touring canoe. It is fairly easy to maneuver in Class II rapids.

- *Cruising* canoes are faster than touring models; they are designed for experienced canoeists who want maximum flat-water speed. Their rounded hulls show a modest V, and they are about 18 feet long. They are another medium-volume canoe.

- *Wilderness-tripping* canoes are also about 18 feet long, but they are wider than cruising canoes and thus have greater volume. Their bottoms tend to be rounded with a slight V; they can handle rough water, but they are not whitewater craft.

- *Whitewater* canoes are the real play boats of the rapids and roly rock-garden waters, built with extreme rocker, high sides to keep out the water, and flat bottoms for maneuverability. Solo models may be only 13 feet long, and tandem models are up to 16 feet.

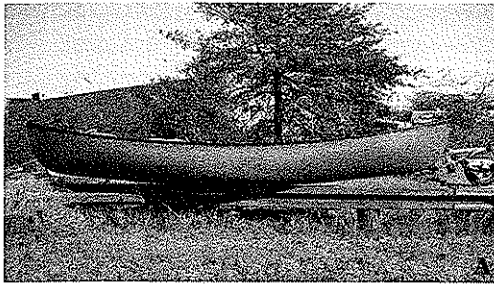

(A) A modern development is the canoe designed chiefly for serious, solo whitewater canoeing. It is wide, short, and has an extreme rocker, which is clearly visible in the photograph. (B) The canoe is designed to carry two sturdy flotation bags at bow and stern, with space for the paddler midships.

- *Decked* canoes are also known as C-1 or C-2 models, depending on whether they carry one or two passengers. Used for whitewater and slalom racing, they look much like kayaks since they, too, have a covering that is an integral part of the canoe with openings for each paddler. Kayakers sit on the deck, or bottom, of the kayak, however, whereas paddlers in decked canoes either kneel or sit on seats.
- *Competition-cruising* canoes are made to go fast, fast, fast; speed is the top priority, so the profile is long, slim, and low. They may be up to 18½ feet long and are for highly skilled paddlers only.
- *Downriver* canoes, also built for fast paddling, are sometimes used by experienced racers. Usually 17 feet long, they have vertical ends.
- *Sportsman* models are wide, stable craft, sometimes with flotation bars along the outwales. Designed chiefly for fishermen and hunters, they are sometimes built with square sterns to hold a small motor.
- *Sport* canoes are akin to the weekenders. They offer a compromise between tracking and maneuverability and usually measure between 15 and 16 feet. They are best suited for easy trips, and for simply having a pleasant time on flat water.
- *Freighter* canoes (yes, they still make a few for wilderness travel) are behemoths of the waterways that can be 20 to 30 feet long and carry up to 5,000 pounds of equipment, plus the paddlers.



The flat bottom with only a slight rocker marks this canoe as a typical river cruising model. It is very stable and easy to turn, yet it will hold a steady course.

- *Specialty* canoes don't fit into any specific category. The outdoor writer Nessmuk had a canoe once made for him that weighed a mere 16 pounds, and it was all wood. It would carry little more than a paddler and a few pounds of gear.

Canoe Materials

Birchbark, Wood, and Canvas

All wood canoes are made much the same way today as they have been for generations. First a keel is laid. Then wood strips are steamed and curved to form ribs that are fastened to the keel and to wooden gunnels. Finally, the outside of the ribs is covered with wood planks, and the seats, thwarts, and other essential parts are added.

If the planks are sheets of specially cut and seasoned birchbark, the result is a birchbark canoe. These are still produced on a limited scale by a few skilled craftspersons. On the other hand, if the planks are covered with canvas, the result is the famous wood-canvas canoe, which was the standard model for many years, having superseded the birchbark, and only began to become scarce after World War II. If the planks are made of attractive wood and are masterfully finished and fitted, the result is the all-wood canoe.

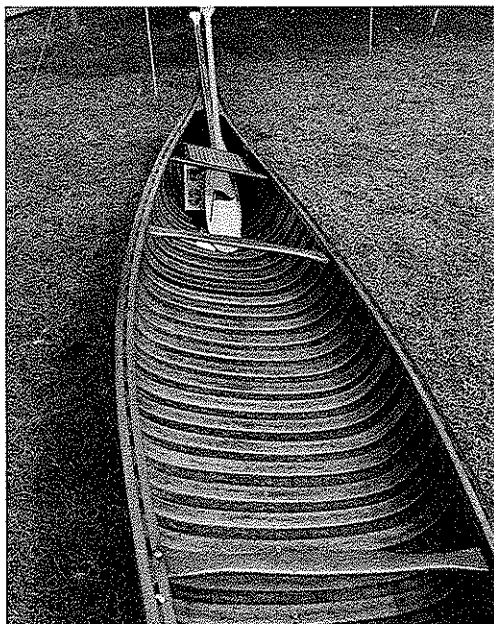

The once universal wood-and-canvas canoe is now either an antique or a custom-made specialty item for affluent canoeists. Note how carefully each rib is installed in this beautiful example.

In all three instances the outer covering is given a special treatment both to protect it from scrapes and bangs and to preserve it against the disintegrating effect of water. Birchbark canoes are usually coated with spar varnish, or they may be covered with a clear fiberglass. Wood canoes with decorative planking may be covered with clear fiberglass, spar varnish, or high-density polyurethane. Canoes with canvas-covered planking go through a more elaborate process. The canvas is coated with a silica-based liquid, then cured under heat for several weeks. It is then sanded to a satin-smooth finish and coated with spar varnish or polyurethane.

Wooden canoes are superbly useful. They can sustain a great deal of punishment. They can be repaired if injured and, if properly cared for, will last for decades. But they are heavy.

Aluminum

There is nothing extraordinarily difficult about manufacturing an aluminum canoe. A sheet of corrosion-resistant aluminum is placed over a mold and pressed into shape at a pressure

of around 3,000 pounds per square inch. The same mold is used to press both halves. The half shells are cleaned, trimmed, and drilled so that they can be riveted together. Then they are heated to a T-6 temper, which makes the aluminum about 35 percent stronger than the original sheets.

After that, the two halves are riveted together. Rivets generally are anodized aluminum, with the heads set flush to minimize damage in an accident.

The most complex part of the assembly is fastening the keel. The keel is not needed on a canoe for directional stability (as it is on a sailboat), but it is essential for structural strength. The most satisfactory method of assembly is to place a gasket atop the keel, put the hull halves together on top of the gasket, butting each other, place another plate over the halves, and rivet all the parts together. A less satisfactory method is simply to overlap the halves and rivet them to the keel (fig. 6).

Grumman, which pioneered the aluminum canoe and gave the world canoeing as a whitewater sport, once produced nine different aluminum models, from 13-foot solo canoes to 19-footers for professional guides. Though the company no longer makes aluminum canoes, there are thousands still bouncing around on rivers and lakes and will be for decades to come. Aluminum canoes have one distinct advantage over the plastics that have replaced them: They never wear out.

But, aluminum canoes do have their drawbacks. They tend to be noisy, slapping against the water and resounding when a paddle shaft hits the outwale. If your craft bumps a rock, everyone in your party will hear the boom. Aluminum canoes also hang up on rocks that canoes made of synthetics will slide off. And they often seem either too hot or too cold. The fact is, they get no hotter or colder than canoes made of any other material, but they do heat up and cool off faster.

In addition, aluminum craft will dent and bend with sufficient impact. The dents remain until they are removed in a shop (or are stomped on with heavy shoes). Serious tears and cracks are not so easy to mend; they need a patch of aluminum riveted over the break. But if you don't wrap your aluminum canoe around a rock somewhere, and you give it only the most casual care, your grandchildren will be paddling it someday.

Fiberglass

Fiberglass, a product of World War II research, emerged as a canoe material not long after Grumman began stamping out aluminum craft. The material used is poly-

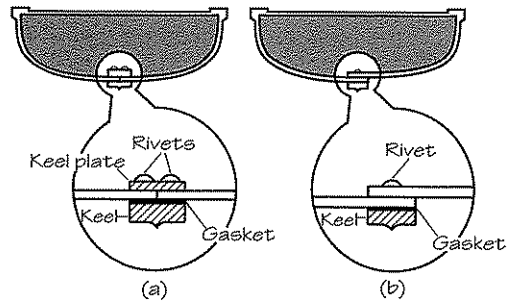

Figure 6

ester plastic reinforced with glass fibers. Making a fiberglass canoe is a hands-on project, and you can get a kit if you want to make one in your own basement—though be sure you can get it out when it is finished. The vast majority are professionally fashioned.

The process begins with a “plug,” a wooden mold that is really a wooden canoe with all the external features the fiberglass canoe will have. The plug is coated with a gel that, in turn, is coated with a couple of thin layers of resin-soaked fiberglass to produce a “female” mold. When thoroughly set, the female mold is removed from the plug and checked on the inside to make certain there are no blemishes.

The inside of the female mold is coated first with a special wax and then a gel, which will become the *outside* of the fiberglass canoe. Next, glass cloth is placed inside the female mold and wetted with a laminating resin, then smoothed by hand with a brush and roller. Varying thicknesses of glass cloth may be used—perhaps three layers of 10-ounce cloth and one of 6-ounce cloth; the formulas vary.

After the basic layers of cloth are laid, additional strips of fiberglass are added to strengthen the bilges and stiffen critical areas.

In a less expensive method, a “chopper gun” is used to spray a mixture of short glass fibers and resin onto a mold. The chopper canoes are considerably cheaper than hand-laid fiberglass, but they are heavier and less serviceable.

In both hand-laid and chopper canoes, the thwarts, gunnels, seats, and decks are added after the fiberglass has thoroughly cured. These canoes are easily repaired using kits that include fiberglass cloth and the impregnating resins.

ABS

Modern plastic canoes, made of ABS (acrylonitrile-butadiene-styrene), can best be described as sandwiches. The outer layer might be a vinyl skin to protect the craft from ultraviolet rays, then two layers of ABS, three layers of foam, two layers of ABS, and a final vinyl layer.

The ABS resists penetration by sharp objects but is too rubbery to make a sturdy canoe hull. The foam adds stiffness, and the final sandwich is not only rigid, but unusually durable and reasonably light.

When a canoe is made, sheets of the ABS sandwich are heated to around 305 degrees F and pushed into a female canoe mold, either by hydraulic rams or by suction. As the sandwich is heated, the layer of foam expands. Its millions of air bubbles make the canoe somewhat buoyant; to make it more so, flotation blocks are often

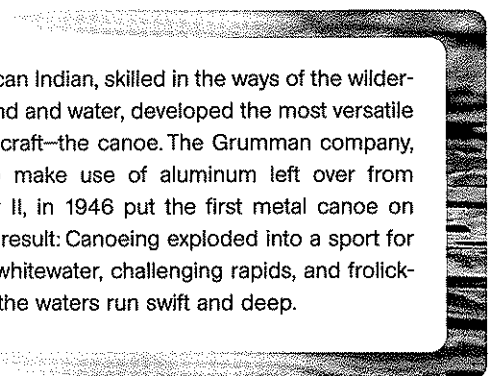

The American Indian, skilled in the ways of the wilderness on land and water, developed the most versatile of all river craft—the canoe. The Grumman company, seeking to make use of aluminum left over from World War II, in 1946 put the first metal canoe on water. The result: Canoeing exploded into a sport for playing in whitewater, challenging rapids, and frolicking where the waters run swift and deep.

added under the seats or the bow and stern decks.

There is one danger with seats with flotation blocks: Some come so close to the bottom of the canoe that a paddler's feet can get wedged under the seat, a deadly prospect if the canoe capsizes.

ABS canoes are unusually durable, and the plastic slides easily off rocks. The canoes can withstand the most shocking treatment. I have seen an ABS canoe wrapped around a rock like a horseshoe and then spring back to its original shape once it was pulled free—wrinkled, but otherwise undamaged. The wrinkles can be removed by heat, but removal should be done by an expert, not a garage mechanic with a blowtorch.

Within the industry some ABS canoes are known as Royalex.

Polyethylene

Polyethylene canoes are made of a plastic resin blended with heat stabilizers and ultraviolet inhibitors. The material is tough, resists impacts, and has a "memory" so that the canoe will bounce back to its original shape after a major bending on a rock. Indeed, Old Town demonstrates the toughness of its Discovery canoe, made of a specially formulated polyethylene, by crushing it against a wall with a truck in reverse; the canoe returns to its original shape. Still, even these canoes can be cracked and broken under extreme circumstances.

Polyethylene is popular for both canoes and kayaks because it can be molded more precisely than ABS—an especially important factor in whitewater and racing craft. Polyethylene is also more flexible than ABS, making it somewhat easier to handle in shallow water and rock gardens.

Polyethylene canoes are made much as ABS canoes are—sheets of the material are heated and molded. After cooling, the hull is completed with the necessary hardware.

Kevlar

Kevlar 49 is the material of the future. Pound for pound, it is five times as strong as steel. A canoe fashioned from Kevlar is both lighter and stronger than one made from any other widely used material. A 16½-foot cruising canoe made of Kevlar weighs about 45 pounds, as opposed to about 72 pounds for one made of ABS or aluminum. Just imagine how much lighter that Kevlar canoe would be on your next portage.

Kevlar is a golden-yellow fiber originally developed by DuPont in the late 1960s to replace steel cord on aircraft tires. It is woven into fabric much the same way fiberglass is, and almost the same techniques are used in making Kevlar canoes as in making fiberglass canoes. Since the material is more expensive than fiberglass and more difficult to work with, a Kevlar canoe may cost two or three times as much as a fiberglass canoe of equal quality.

Kevlar also is used to reinforce crucial areas of fiberglass and ABS canoes.

The Allagash

Half legend, half history. Half lake, half challenging white water. Meld these together and the result is a tremendous canoe experience—paddling the fabled Allagash Wilderness Waterway as it weaves its way through the great forests of northern Maine.

Established by the state in 1966 to protect a 92-mile long “ribbon of lakes, ponds, rivers, and streams” the Allagash became the first of the country’s National Wild and Scenic rivers in 1970.

Although the Allagash is not a true wilderness, canoeing its waters through a 2-mile-wide band of forested hills and mountains is a true wilderness experience. Fortunately there are occasional campsites sprinkled throughout the rich forests. We found staying at them a pleasure on a recent week’s trip.

Moose munch on underwater grasses as you paddle by. Deer bound along the banks. Eagles and egrets keep you company.

It is possible to take only short trips on lakes, but for those who would like to paddle the entire waterway, previous canoe and camping experience is strongly recommended.

The area appears as remote today as it did when Henry David Thoreau penetrated its deep forests in the mid 1800s and wrote:

“In wilderness is the preservation of the world.”

Even Kevlar may not be the last word in canoe materials. Scientists are developing new types of plastics that are even stronger and lighter. Some, though, are simply too difficult to work with and are far more expensive than Kevlar. But one of these days we’ll all hear of yet another new miracle material for a canoe, lighter and stronger than anything yet paddled on the world’s waterways.

Proprietary Lay-up

This material might best be described as a secret. What the name refers to is the combination of fabrics and resins used by a specific manufacturer for its canoes. The combination is not always revealed to the public.

Transporting a Canoe

Hauling a canoe is a problem that private canoe owners eventually find ways to resolve. On the other hand, paddlers who rent canoes may find it a complicated problem to haul their craft to the river or lake of their choice.

Capsizing

It happens to the best of paddlers and to novices. It happens in Class III water and in quiet ponds. But no matter where or why a canoe capsizes, the first law of the water is to look to the safety of the paddlers. Canoes, gear, food, a six-pack—all can be recovered later. Rescue paddlers first.

If your canoe flips in fast current, move *instantly* to the upstream side of the canoe and grab hold of the craft, holding on until you're in calm water. *Never* hold onto the downstream side of a swamped canoe. If it crushes you against a rock, the result can be disastrous.

If you're thrown clear of the canoe, turn onto your back and float downstream with your feet ahead of you to fend off rocks. Do not try to swim. You cannot swim in a swift current, and trying will only compound a difficult situation.

The only time it makes sense to abandon a canoe is if the water is cold, or the stretch of rapids is long, and/or you are in danger of suffering from hypothermia or exhaustion. Make a quick judgment. Can you reach safety more quickly if you let go of the canoe?

Recovery Techniques

A capsized canoe is not an unusual circumstance. The following scenarios are paired with situations that will get you back in your canoe again.

- *Scenario 1.* The canoe is upside down and lodged against a rock. This almost inevitably means it has filled with water that is held inside the canoe by air pressure. *Solution:* If the current is not too swift, one canoeist moves to the bow, the other to the stern. At a given signal one canoeist lifts his end at the same time the other is depressing hers. This will break the seal of pressure holding water in the canoe. As the water pours out, flip the canoe back upright. (In a strong current one end of the empty canoe will start to swing downstream, so be prepared.)
- *Scenario 2.* The canoe is half-swamped from a heavy wave but is still upright. *Solution:* Paddle immediately to a shallow point where you can get out and tilt the canoe to empty it, or head for the nearest shore, pull the canoe up on the bank, and roll it over.
- *Scenario 3.* The canoe is upright but is stuck atop a monstrous rockopotamus sleeping under a pillow. *Solution:* First, rock the canoe from side to side to edge it into the current. If that doesn't work, put a foot over the edge and try to shove the craft off the rock. If *that* doesn't work, step out of the canoe and push it off the rock while holding onto the gunnel or the painter so that the canoe does not go bouncing off without you.
- *Scenario 4.* The canoe is badly wedged into rocks or other obstructions and cannot be jiggled, joggled, or maneuvered loose. *Solution:* Use ropes to haul it free.