

91

*(This copy of the 1894 Manual is taken from an original volume in the possession of the BLM, Oregon State Office, Portland.)*

**1894  
MANUAL  
OF  
SURVEYING INSTRUCTIONS  
FOR THE  
SURVEY OF THE PUBLIC LANDS  
OF THE  
UNITED STATES  
AND  
PRIVATE LAND CLAIMS.**

---

Prepared in conformity with law under the direction of  
THE COMMISSIONER OF THE GENERAL LAND OFFICE.

---

JUNE 30, 1894.

---

WASHINGTON:  
GOVERNMENT PRINTING OFFICE.  
1894.

GENTLEMEN:

The following instructions, including full and minute directions for the execution of surveys in the field, are issued under the authority given me by sections 453, 456, and 2398, United States Revised Statutes, and must be strictly complied with by yourselves, your office assistants, and deputy surveyors.

All directions in conflict with these instructions are hereby abrogated.

In all official communications, this edition will be known and referred to as the Manual of 1894.

Very respectfully,

S. W. LAMOREUX,  
*Commissioner.*

To SURVEYORS GENERAL OF THE UNITED STATES.

-5-

**MANUAL OF SURVEYING  
 INSTRUCTIONS.**

**HISTORY OF LEGISLATION FOR SURVEYS.**

The present system of survey of the public lands was inaugurated by a committee appointed by the Continental Congress, consisting of the following delegates:

- Hon. THOS. JEFFERSON, *Chairman* . . . . . Virginia.
- Hon. HUGH WILLIAMSON . . . . . North Carolina.
- Hon. DAVID HOWELL . . . . . Rhode Island.
- Hon. ELBRIDGE GERRY . . . . . Massachusetts.
- Hon. JACOB READ . . . . . South Carolina.

On the 7th of May, 1784, this committee reported "An ordinance for ascertaining the mode of locating and disposing of lands in the western territory, and for other purposes therein mentioned." This ordinance required the public lands to be divided into "hundreds" of ten geographical miles square, and those again to be subdivided into lots of one mile square each, to be numbered from 1 to 100, commencing in the *north-western* corner, and continuing from west to east and from east to west consecutively. This ordinance was considered, debated, and amended, and reported to Congress April 26, 1785, and required the surveyors "to divide the said territory into townships of 7 miles square, by lines running due north and south, and others crossing these at right angles. \* \* \* The plats of the townships, respectively, shall be marked by subdivisions into sections of 1 mile square, or 640 acres, in the same direction as the external lines, and numbered from 1 to 49. \* \* \* And these sections shall be subdivided into lots of 320 acres." This is the first record of the use of the terms "township" and "section."

May 3, 1785, on motion of Hon. William Grayson, of Virginia, seconded by Hon. James Monroe, of Virginia, the sec-

tion respecting the extent of townships was amended by striking out the words "seven miles square" and substituting the words "six miles square." The records of these early sessions of Congress are not very full or complete; but it does not seem to have occurred to the members until the 6th of May, 1785, that a township six miles square could not contain 49 sections of 1 mile square. At that date a motion to amend was made, which provided, among other changes, that a township should contain 36 sections; and the amendment was *lost*. The ordinance as finally passed, however, on the 20th of May, 1785, provided for townships 6 miles square, containing 36 sections of 1 mile square. The first public surveys were made under this ordinance. The townships, 6 miles square, were laid out in ranges, extending northward from the Ohio River, the townships being numbered from south to north, and the ranges from east to west. The region embraced by the surveys under this law forms a part of the present State of Ohio, and is usually styled "The

-6-

Seven Ranges." In these initial surveys only the *exterior lines* of the townships were surveyed, but the plats were marked by subdivisions into sections of 1 mile square, and mile corners were established on the township lines. The sections were numbered from 1 to 36, commencing with No. 1 in the *south-east* corner of the township, and running from *south to north* in each tier to No. 36 in the *northwest* corner of the township, as shown in the following diagram:

36	30	24	18	12	6
35	29	23	17	11	5
34	28	22	16	10	4
33	27	21	15	9	3
32	26	20	14	8	2
31	25	19	13	7	1

The surveys were made under the direction of the Geographer of the United States.

The act of Congress approved May 18, 1796, provided for the appointment of a surveyor general, and directed the survey of the lands northwest of the Ohio River, and above the mouth of the Kentucky River, "in which the titles of the Indian tribes have been extinguished." Under this law *one half* of the townships surveyed were subdivided into sections "by running through the same, each way, parallel lines at the end of every two miles, and by making a corner on each of said lines at the end of every mile," and it further provided that "the sections shall be numbered, respectively, beginning with the number one in the northeast section and proceeding west and east alternately, through the township, with progressive numbers till the thirty-sixth be completed." This method of numbering sections, as shown by the following diagram, is still in use:

6	5	4	3	2	1
7	8	9	10	11	12
18	17	16	15	14	13
19	20	21	22	23	24
30	29	28	27	26	25
31	32	33	34	35	36

The act of Congress approved May 10, 1800, required the "townships west of the Muskingum, which \* \* \* are directed to be sold in quarter townships, to be subdivided into half sections of three hundred

-7-

and twenty acres each, as nearly as may be, by running parallel lines through the same from east to west, and from south to north, at the distance of one mile from each other, and marking corners, at the distance of each half mile, on the lines running from east to west, and at the distance of each mile on those running from south to north. \* \* \* And the interior lines of townships intersected by the Muskingum, and of all the townships lying east of that river, which have not been heretofore actually subdivided into sections, shall also be run and marked. \* \* \* And in all cases where the exterior lines of the townships thus to be subdivided into sections or half sections shall exceed, or shall not extend, six miles, the excess or deficiency shall be specially noted, and added to or deducted from the western and northern ranges of sections or half sections in such townships, according as the error may be in running the lines from east to west or from south to north."

The act of Congress approved February 11, 1805, directs the subdivision of the public lands into quarter sections, and provides that all the corners marked in the public surveys shall be established as the proper corners of sections, or subdivisions of sections, which they were intended to designate, and that corners of half and quarter sections *not marked* shall be placed, as nearly as possible, "equidistant from those two corners which stand on the same line." This act further provides that "The boundary lines actually run and marked \* \* \* shall be established as the proper boundary lines of the sections or subdivisions for which they were intended; and the length of such lines as returned by \* \* \* the surveyors \* \* \* shall be held and considered as the true length thereof, and the boundary lines which shall not have been actually run and marked as aforesaid shall be ascertained by running straight lines from the established corners to the opposite corresponding corners; but in those portions of the fractional townships, where no such opposite or corresponding corners have been or can be fixed, the said boundary line shall be ascertained by running from the established corners due north and south or east and west lines, as the case may be, to the \* \* \* external boundary of such fractional township."

The act of Congress approved April 25, 1812, provided "That there shall be established in the Department of the

Treasury an office to be denominated the General Land Office, the chief officer of which shall be called the Commissioner of the General Land Office, whose duty it shall be, under the direction of the head of the Department, to superintend, execute, and perform all such acts and things touching or respecting the public lands of the United States, and other lands patented or granted by the United States, as have heretofore been directed by law to be done or performed in the office of the Secretary of State, of the Secretary and Register of the Treasury, and of the Secretary of War, or which shall hereafter by law be assigned to the said office."

The act of Congress approved April 24, 1820, provides for the sale of public lands in half quarter sections, and requires that "in every case of the division of a quarter section the line for the division thereof shall run north and south \* \* \* and fractional sections, containing 160 acres and upward, shall, in like manner, as nearly as practicable, be subdivided into half quarter sections, under such rules and regulations as may be prescribed by the Secretary of the Treasury; but fractional sections containing less than 160 acres shall not be divided."

The act of Congress approved May 24, 1824, provides "That whenever, in the opinion of the President of the United States, a departure

-8-

from the ordinary mode of surveying land on any river, lake, bayou, or water course would promote the public interest, he may direct the surveyor general in whose district such land is situated, and where the change is intended to be made, under such rules and regulations as the President may prescribe, to cause the lands thus situated to be surveyed in tracts of two acres in width, fronting on any river, bayou, lake, or water course, and running back the depth of forty acres."

The act of Congress approved May 29, 1830 (secs. 2412, 2413, R. S.), provides for the fine and imprisonment of any person obstructing the survey of the public lands, and for the protection of surveyors, in the discharge of their official duties, by the United States marshal, with sufficient force, whenever necessary.

The act of Congress approved April 5, 1832, directed the subdivision of the public lands into quarter quarters; that in every case of the division of a half quarter section the dividing line should run east and west; and that fractional sections should be subdivided under rules and regulations prescribed by the Secretary of the Treasury. Under the latter provision the Secretary directed that fractional sections containing less than 160 acres, or the residuary portion of a fractional section, after the subdivision into as many quarter quarter sections as it is susceptible of, may be subdivided into lots, each containing the quantity of a quarter quarter section, as nearly as practicable, by so laying down the line of subdivision that they shall be 20 chains wide, which distances are to be marked on the plat of subdivision, as are also the areas of the quarter quarters and residuary fractions.

The last two acts above mentioned provided that the corners and contents of half-quarter and quarter-quarter sections should be ascertained, as nearly as possible, in the manner and on the principles directed and prescribed in the act of Congress approved February 11, 1805.

[See Plates I, III, and IV.]

The act of Congress approved July 4, 1836, provided for the reorganization of the General Land Office, and that the executive duties of said office "shall be subject to the supervision and control of the Commissioner of the General Land Office under the direction of the President of the United States." The repealing clause is, "That such provisions of the act of the twenty-fifth of April, in the year one thousand eight hundred and twelve, entitled 'An act for the establishment of a General Land Office in the Department of the Treasury,' and of all acts amendatory thereof, as are inconsistent with the provisions of this act, be, and the same are hereby, repealed."

From the wording of this act it would appear that the control of the General Land Office was removed from the Treasury Department, and that the Commissioner reported directly to the President; but, as a matter of fact, the Secretary of the Treasury still had supervisory control, for the act of Congress approved March 3, 1849, by which the Department of the Interior was established, provided, "That the Secretary of the Interior shall perform all the duties in relation to the General Land Office, of supervision and appeal, now discharged by the Secretary of the Treasury \* \* \*." By this act the General Land Office was transferred to the Department of the Interior, where it still remains.

In 1855 a manual of instructions to surveyors general was prepared, under the direction of the Commissioner of the General Land Office, by John M. Moore, then principal clerk of surveys, and the act of Congress approved May 30, 1862 (sec. 2399, R. S.), provided "That the printed manual of instructions relating to the public surveys, prepared at the General Land Office, and bearing the date February twenty-second, eighteen hundred and fifty-five, the instructions of the Commissioner

-9-

of the General Land Office, and the special instructions of the surveyor general, when not in conflict with said printed manual or the instructions of said Commissioner, shall be taken and deemed to be a part of every contract for surveying the public lands of the United States."

The instructions contained in this volume are issued under the authority given in the clause in said act providing that "The instructions of the Commissioner of the General Land Office \* \* \* shall be taken and deemed to be a part of every contract for surveying the public lands of the United States."

The following comprises so much of the general laws relating to the survey of the public domain as it is deemed necessary to incorporate in this volume, reference being made by chapter and section to the codification of the Public Land Laws, prepared pursuant to acts of Congress approved March 3, 1879 and June 16, 1880, and by section number to the Revised Statutes of the United States.

*(The remainder of page 9, all of pages 10 through 16 and most of page 17 are deleted. They contain the pertinent Revised Statutes, and forms of contracts.)*

1. Existing law requires that in general the public lands of the United States "shall be divided by north and south lines run according to the true meridian, and by others crossing them at right angles so as to form townships six miles square," and that the corners of the townships thus surveyed "must be marked with progressive numbers from the beginning."

-18-

Also, that the townships shall be subdivided into thirty-six sections, each of which shall contain six hundred and forty acres, as nearly as may be, by a system of two sets of parallel lines, one governed by true meridians and the other by parallels of latitude, the latter intersecting the former at right angles, at intervals of a mile.

2. In the execution of the public surveys under existing law, it is apparent that the requirements that the lines of survey shall conform to true meridians, and that the townships shall be 6 miles square, taken together, involve a mathematical impossibility due to the converg of the meridians.

Therefore, to conform the meridional township lines to the true meridians produces townships of a trapezoidal form which do not contain the precise area of 23,040 acres required by law, and which discrepancy increases with the increase in the convergency of the meridians, as the surveys attain the higher latitudes.

In view of these facts, and under the provisions of section 2 of the act of May 18, 1796, that sections of a mile square shall contain 640 acres, *as nearly as may be*, and also under those of section 3 of the act of May 10, 1800, that "in all cases where the exterior lines of the townships, thus to be subdivided into sections and half sections, shall exceed, or shall not extend 6 miles, the excess or deficiency shall be specially noted, and added to or deducted from the western or northern ranges of sections or half sections in such township, according as the error may be in running lines from east to west, or from south to north; the sections and half sections bounded on the northern and western lines of such townships shall be sold as containing only the quantity expressed in the returns and plats, respectively, and all others as containing the complete legal quantity," the public lands of the United States shall be surveyed under the methods of the system of rectangular surveying, which harmonizes the incompatibilities of the requirements of law and practice, as follows:

*First.* The establishment of a principal meridian conforming to the true meridian, and, at right angles to it, a base line conforming to a parallel of latitude.

*Second.* The establishment of standard parallels conforming to parallels of latitude, initiated from the principal meridian at intervals of 24 miles and extended east and west of the same.

*Third.* The establishment of guide meridians conforming to true meridians, initiated upon the base line and successive standard parallels at intervals of 24 miles, resulting in tracts of land 24 miles square, *as nearly as may be*, which shall be

subsequently divided into tracts of land 6 miles square by two sets of lines, one conforming to true meridians, crossed by others conforming to parallels of latitude at intervals of 6 miles, containing 23,040 acres, *as nearly as may be*, and designated *townships*.

Such townships shall be subdivided into thirty-six tracts, called sections, each of which shall contain 640 acres, as nearly as may be, by two sets of parallel lines, one set *parallel to a true meridian* and the other *conforming to parallels of latitude*, mutually intersecting at intervals of 1 mile and at right angles, *as nearly as may be*.

Any series of contiguous townships situated north and south of each other constitutes a *range*, while such a series situated in an east and west direction constitutes a *tier*.

The accompanying diagram (Plate III), and the specimen field notes (page 142), pertaining to the same, will serve to illustrate the method of running lines to form tracts of land 24 miles square, as well as the

-19-

method of running out the exterior lines of townships, and the order and mode of subdividing townships will be found illustrated in the accompanying specimen field notes (page 172), conforming with the township plat (Plate IV). The method here presented is designed to insure as full a compliance with all the requirements, meaning, and intent of the surveying laws as practicable.

The section lines are surveyed from *south* to north<sup>1</sup> and from *east* to west, in order to throw the excess or deficiency in measurement on the north and west sides of the township, as required by law. In case where a township has been partially surveyed, and it is necessary to complete the survey of the same, or where the character of the land is such that only the north or west portions of the township can be surveyed, this rule can not be strictly adhered to, but, in such cases, it will be departed from only so far as is absolutely necessary. It will also be necessary to depart from this rule where surveys close upon State or Territorial boundaries, or upon surveys extending from different meridians.

3. The tiers of townships will be numbered, to the north or south, commencing with No. 1, at the base line; and the ranges of the townships, to the east or west, beginning with No. 1, at the principal meridian of the system.

4. The thirty-six sections into which a township is subdivided are numbered, commencing with number *one* at the *northeast* angle of the township, and proceeding west to number six, and thence proceeding east to number twelve, and so on, alternately, to number thirty-six in the southeast angle. In all cases of surveys of fractional townships, the sections will bear the same numbers they would have if the township was full.

5. Standard parallels shall be established at intervals of every 24 miles, north and south of the base line, and guide meridians at intervals of every 24 miles, east and west of the principal meridian; thus confining the errors resulting from convergence of meridians and inaccuracies in measurement within comparatively small areas.

6. The surveys of the public lands of the United States, embracing the establishment of base lines, principal meridians, standard parallels, meander lines, and the subdivisions of townships, will be made with instruments provided with the accessories necessary to determine a direction with reference to the true meridian, independently of the magnetic needle.

Burt's improved solar compass, or a transit of approved construction, with or without solar attachment, will be used in *all cases*. When a transit *without* solar attachment is employed, *Polaris observations* and the *retracements* necessary to execute the work in accordance with existing law and the requirements of these instructions will be insisted upon.

7. Deputies using instruments with solar apparatus will be required to make observations on the star *Polaris* at the beginning of every survey, and, *whenever necessary*, to test the accuracy of the solar apparatus.

The observations required to test the adjustments of the solar apparatus will be made at the corner where the survey begins, or at the

-20-

camp of the deputy surveyor nearest said corner; and in all cases the deputy will fully state in the field notes the exact location of the observing station.

Deputy surveyors will examine the adjustments of their instruments, and take the *latitude*<sup>2</sup> *daily*, weather permitting, while running *all lines of the public surveys*. They will make complete records in their field notes, under proper dates, of the making of all observations in compliance with these instructions, showing the character and condition of the instrument in use, and the precision attained in the survey, by comparing the direction of the line run with the meridian determined by observation.

On every survey executed with solar instruments, the deputy will, *at least once on each working day*, record in his field notes the proper reading of the latitude arc; the declination of the sun, corrected for refraction, set off on the declination arc; and note the correct *local mean time* of his observation, which, for the record, will be taken *at least two hours from apparent noon*.

8. The construction and adjustments of all surveying instruments used in surveying the public lands of the United States will be tested at least once a year, and oftener, if necessary, on the true meridian, established under the direction of the surveyor general of the district; and if found defective, the instruments shall undergo such repairs or modifications as may be found necessary to secure the closest possible approximation to accuracy and uniformity in all field work controlled by such instruments.

A record will be made of such examinations, showing the number and character of the instrument, name of the maker, the quantity of instrumental error discovered by comparison, in either solar or magnetic apparatus, or both, and means taken to correct the same. The surveyor general will allow no

1. See "Method of Subdividing," p. 53.

2. The adjustments should be verified daily when the instrument is in use.

surveys to be made until the instruments to be used therefor have been approved by him.

9. The township and subdivision lines will usually be measured by a two-pole chain of 33 feet in length,<sup>3</sup> consisting of 50 links, each link being seven and ninety-two hundredths inches long. On uniform and level ground, however, the four-pole chain may be used. The measurements will, however, always be expressed in terms of the four-pole chain of 100 links. The deputy surveyor shall provide himself with a measure of the standard chain kept at the office of the surveyor general, to be used by him as a field standard. The chain in use will be compared and adjusted with this field standard each working day, and such field standard will be returned to the surveyor general's office for examination when the work is completed.

Deputy surveyors will use eleven tally pins made of steel, not exceeding 14 inches in length, weighty enough toward the point to make them drop perpendicularly, and having a ring at the top, in which will be fixed a piece of red cloth, or something else of conspicuous color, to make them readily seen when stuck in the ground.

### PROCESS OF CHAINING.

In measuring lines with a two-pole chain, *five* chains are called a "tally," and in measuring lines with a four-pole chain, *ten* chains are called a "tally," because at that distance the last of the ten

-21-

tally pins with which the forward chainman sets out will have been stuck. He then cries "tally," which cry is repeated by the other chainman, and each registers the distance by slipping a thimble, button, or ring of leather, or something of the kind, on a belt worn for that purpose, or by some other convenient method. The hind chainman then comes up, and having counted in the presence of his fellow the tally pins which he has taken up, so that both may be assured that none of the pins have been lost, he then takes the forward end of the chain, and proceeds to set the pins. Thus the chainmen alternately change places, each setting the pins that he has taken up, so that one is forward in all the odd, and the other in all the even tallies. Such procedure, it is believed, tends to insure accuracy in measurement, facilitates the recollection of the distances to objects on the line, and renders a mistally almost impossible.

### LEVELING THE CHAIN AND PLUMBING THE PINS.

1. The length of every surveyed line will be ascertained by precise horizontal measurement, as nearly approximating to an air line as is possible in practice on the earth's surface. This all-important object can only be attained by a rigid adherence to the three following observances:

*First.* Ever keeping the chain drawn to its utmost degree of tension on even ground.

*Second.* On uneven ground, keeping the chain not only stretched as aforesaid, but *leveled*. And when ascending and

descending steep ground, hills or mountains, the chain will have to be *shortened* to one-half or one-fourth its length (and sometimes more), in order accurately to obtain the true horizontal measure.

*Third.* The careful plumbing of the tally pins, so as to attain precisely the *spot* where they should be stuck. The more uneven the surface, the greater the caution needed to set the pins.

### MARKING LINES.

1. All lines on which are to be established the legal corner boundaries will be marked after this method, viz: Those trees which may be intersected by the line will have two chops or notches cut on the sides facing the line, without any other marks whatever. These are called "*sight trees*" or "*line trees*." A sufficient number of other trees standing within 50 links of the line, on either side of it, will be *blazed* on two sides diagonally or quartering toward the line, in order to render the line conspicuous, and readily to be traced, the blazes to be opposite each other, coinciding in direction with the line where the trees stand very near it, and to approach nearer each other toward the line, the farther the line passes from the blazed trees. Due care will ever be taken to have the lines so well marked as to be readily followed, and to cut the blazes deep enough to leave recognizable scars as long as the trees stand.

Where trees 2 inches or more in diameter are found, the required blazes will not be omitted.

Bushes on or near the line should be bent at right angles therewith, and receive a blow of the ax at about the usual height of blazes from the ground sufficient to leave them in a bent position, but not to prevent their growth.

-22-

2. On trial or random lines, the trees will not be blazed, unless occasionally, from indispensable necessity, and then it will be done so guardedly as to prevent the possibility of confounding the marks of the trial line with the *true*. But bushes and limbs of trees may be lopped, and *stakes set* on the trial or random line, at every ten chains, to enable the surveyor on his return to follow and correct the trial line and establish therefrom the *true line*. To prevent confusion, the temporary stakes set on the trial or random line will be *pulled up* when the surveyor returns to establish the true line.

### INSUPERABLE OBJECTS ON LINE— WITNESS POINTS.

1. Under circumstances where the survey of a township or section line is obstructed by an impassable obstacle, such as a pond, swamp, or marsh (not meanderable), the line will be prolonged across such obstruction by making the necessary right-angle offsets (Plate IV, sec. 22); or, if such proceeding is impracticable, a traverse line will be run, or some proper trigonometrical operation will be employed to locate the line on the opposite side of the obstruction; and in case the line, either *meridional* or *latitudinal*, thus regained, is recovered beyond the intervening obstacle, said line will be surveyed back to the margin of the obstruction and *all the particulars*,

3. See R. S. 2395, sec. 99, par. 6 (page 11).

in relation to the field operations, will be fully stated in the field notes.

2. As a guide in alinement and measurement, at each point where the line intersects the margin of an obstacle, a *witness point*<sup>4</sup> will be established, *except* when such point is less than 20 *chains* distant from the true point for a legal corner which falls in the obstruction, in which case a *witness corner*<sup>5</sup> will be established at the intersection. (See Plate IV, section 22.)

3. In a case where all the points of intersection with the obstacle to measurement fall *more than 20 chains* from the proper place for a legal corner in the obstruction, and a witness corner can be placed on the offset line *within 20 chains* of the inaccessible corner point, such "witness corner" will be established. (See Plate IV, south boundary of section 16.)

### ESTABLISHING CORNERS.

1. To procure the faithful execution of this part of a surveyor's duty, is a matter of the utmost importance. After true coursing and most exact measurements, the establishment of corners is the consummation of the field work. Therefore, if the corners be not perpetuated in a permanent and workman-like manner, the *principal object* of surveying operations will not have been attained.

2. The points at which corners will be established are fully stated in the several articles: "Base Lines," "Principal Meridians," "Standard Parallels," etc., following the title "Initial Points," page 50.

3. The best marking tools adapted to the purpose will be provided for marking *neatly, distinctly, and durably*, all the letters and figures required to be made at corners, *arabic* figures being used exclusively; and the deputy will always have at hand the necessary implements for keeping his marking irons in perfect order.

### DESCRIPTIONS OF CORNERS.

1. The form and language used in the following articles, in describing, for each one of the thirteen classes of corners, eight specific construc-

-23-

tions and markings, with the stated modifications in certain cases, will be carefully followed by deputy surveyors in their *field notes*; and their *field work* will strictly comply with the requirements of the descriptions.

2. When pits and mounds of earth are made accessories to corners, the pits will always have a *rectangular* plan; while the mounds will have a *conical* form, with *circular* base; and in all cases both pits and mounds will have dimensions *at least* as great as those specified in the descriptions. Deputy surveyors will strictly adhere to these provisions, and no departure from the stated requirements will be permitted, either in *instructions or practice in the field*. (See Plates V and VI).

4. See "Witness Points," page 48.

5. See "Witness Corners," page 47.

6. The direction of the mound, from the corner, will be stated whenever a mound is built. See "Miscellaneous," par. 2, page 48.

3. Referring to the numbered paragraphs, the corners described in "3" will be preferred to those described in either "1" or "2", when corners are established in loose, sandy soil, and good bearing trees are available; under similar conditions, the corners described in "5" and "8" will be preferred to those described in "4" and "7", respectively.

4. The selection of the particular construction to be adopted in any case will be left, as a matter of course, to the judgment and discretion of the deputy, who will assign the greatest weight to the *durability* of the corner materials and permanency of the finished corners.

5. The following abbreviations and contractions will be used in the descriptions of corners, viz:

A. M. C.	for auxiliary meander corner.	N.	for north.
bdy.	for boundary.	¼ sec. cor.	for quarter section corner.
bdrs.	for boundaries.	R.	for range.
bet.	for between.	Rs.	for ranges.
C. C.	for closing corner.	sec., secs.	for section, sections.
cor. cors.	for corner, corners.	S. M. C.	for special meander corner.
dist.	for distance.	s. c.	for standard corner.
E.	for east.	sq.	for square.
ft.	for foot or feet.	S.	for south.
fracl.	for fractional.	T. or Tp.	for township.
ins.	for inches.	Ts. or Tps.	for townships.
diam.	for diameter.	W.	for west.
lks.	for links.	W. C.	for witness corner.
M. C.	for meander corner.	W. P.	for witness point.

For "18 inches long, 7 inches wide, 6 inches thick," in describing a corner stone, write "18 x 7 x 6 ins.," being particular to always preserve the same order of length, width, and thickness (or depth), and use a similar form when describing *pits*.

### STANDARD TOWNSHIP CORNERS.

[See Plates III and V.]

When more than one-half of all the standard township and section corners on any 6 miles of a base line or standard parallel are stone corners, the descriptions in paragraphs 1 and 2, if the corners therein described are established, will be modified as follows: Strike out "S. C., on N." After "marked", insert the words:

"S. C., 13 N. on N.,  
22 E. on E., and  
21 E. on W. faces;"

When under the conditions above specified the corner described in paragraph 1 is established, a stake may be driven in the east pit and marked instead of the stone, and described as exemplified in the last clause of paragraph 6, page 00.

(See Specimen Field Notes, pages 145 and 149.)

-24-

1. *Stone, with Pits and Mound of Earth.*

Set a \_\_\_\_\_ stone, \_\_\_\_\_ x \_\_\_\_\_ x \_\_\_\_\_ ins., \_\_\_\_\_ ins. in the ground, for standard cor. of ( e. g. ) Tps. 13 N., Rs. 21 and 22 E., marked S. C. on N.; with 6 grooves on N., E., and W. faces; dug pits 30 x 24 x 12 ins., crosswise on each line, E. and W., 4 ft., and N. of stone, 8 ft. dist.; and raised a mound of earth, 5 ft. base, 2½ ft. high, N.<sup>6</sup> of cor.



2. *Stone, with Mound of Stone.*

Set a \_\_\_\_\_ stone, \_\_\_\_\_ x \_\_\_\_\_ x \_\_\_\_\_ ins., \_\_\_\_\_ ins. in the ground, for standard cor. of (e. g.) Tps. 13 N., Rs. 21 and 22 E., marked S. C., on N.; with 6 grooves on N., E., and W. faces; and raised amount of stone<sup>7</sup>, 2 ft. base, 1½ ft. high, N. of cor. Pits impracticable.

3. *Stone, with Bearing Trees.*

Set a \_\_\_\_\_ stone, \_\_\_\_\_ x \_\_\_\_\_ x \_\_\_\_\_ ins., \_\_\_\_\_ ins. in the ground, for standard cor. of (e. g.) Tps. 13 N., Rs. 21 and 22 E., marked S. C., on N.; with 6 grooves on N., E., and W. faces; from which

A \_\_\_\_\_, \_\_\_\_\_ ins. diam., bears N. \_\_\_\_\_° E., \_\_\_\_\_ lks. dist., marked<sup>8</sup>  
T. 13 N., R. 22 E., S. 31, B. T.

A \_\_\_\_\_, \_\_\_\_\_ ins. diam., bears N. \_\_\_\_\_° W., \_\_\_\_\_ lks. dist., marked  
T. 13 N., R. 21 E., S. 36, B. T.

4. *Post, with Pits and Mound of Earth.*

Set a \_\_\_\_\_ post, 3 ft. long, 4 ins. sq., with marked stone (charred stake or quart of charcoal), 24 ins. in the ground, for standard cor. of (e. g.) Tps. 13 N., Rs. 22 and 23 E., marked S. C., T. 13 N. on N.,

R. 23 E., S. 31 on E., and

R. 22 E., S. 36 on W. faces; with 6 grooves on N., E., and W. faces; dug pits, 30 x 24 x 12 ins., crosswise on each line, E. and W., 4 ft., and N. of post, 8 ft. dist.; and raised a mound of earth, 5 ft. base, 2½ ft. high, N. of cor.

5. *Post, with Bearing Trees.*

Set a \_\_\_\_\_ post, 3 ft. long, 4 ins. sq., 24 ins. in the ground, for standard cor. of (e. g.) Tps. 13 N., Rs. 22 and 23 E., marked S. C., T. 13 N. on N.,

R. 23 E., S. 31 on E., and

R. 22 E., S. 36 on W. faces; with 6 grooves on N., E., and W. faces, from which

A \_\_\_\_\_, \_\_\_\_\_ ins. diam., bears N. \_\_\_\_\_° E., \_\_\_\_\_ lks. dist., marked  
T. 13 N., R. 23 E., S. 31, B. T.

A \_\_\_\_\_, \_\_\_\_\_ ins. diam., bears N. \_\_\_\_\_° W., \_\_\_\_\_ lks. dist., marked  
T. 13 N., R. 22 E., S. 36, B. T.

6. *Mound of Earth, with Deposit, and Stake in Pit.*

Deposited a marked stone (charred stake or quart of charcoal) 12 ins. in the ground, for standard cor. of (e. g.) Tps. 13 N., Rs. 22 and 23 E.; dug pits, 30 x 24 x 12 ins., crosswise on each line, N., E., and W. of cor., 5 ft. dist.; and raised a mound of earth, 5 ft. base, 2½ ft. high, over deposit.

-25-

In E. pit drove a \_\_\_\_\_ stake, 2 ft. long, 2 ins. sq., 12 ins.

7. Mound of stone will consist of not less than four stones, and will be at least 1½ ft. high, with 2 ft. base.

8. All bearing trees, except those referring to quarter section corners, will be marked with the township, range, and section in which they stand.

in the ground, marked

S. C., T. 13 N. on N.,

R. 23 E., S. 31 on E., and

R. 22 E., S. 36 on W. faces; with 6 grooves on N., E., and W. faces.

7. *Tree Corner, with Pits and Mound of Earth.*

A \_\_\_\_\_, \_\_\_\_\_ ins. diam., for standard cor. of (e. g.) Tps. 13 N., Rs. 22 and 23 E., I marked

S. C., T. 13 N. on N.,

R. 23 E., S. 31 on E., and

R. 22 E., S. 36 on W. sides; with 6 notches on N., E., and W. sides; dug pits, 24 x 18 x 12 ins., crosswise on each line, N., E., and W. of cor., 5 ft. dist.; and raised a mound of earth around tree.

8. *Tree Corner, with Bearing Trees.*

A \_\_\_\_\_, \_\_\_\_\_ ins. diam., for standard cor. of (e. g.) Tps. 13 N., Rs. 22 and 23 E., I marked

S. C., T. 13 N. on N.,

R. 23 E., S. 31 on E., and

R. 22 E., S. 36 on W. sides; with 6 notches on N., E., and W. sides; from which

A \_\_\_\_\_, \_\_\_\_\_ ins. diam., bears N. \_\_\_\_\_° E., \_\_\_\_\_ lks. dist., marked  
T. 13 N., R. 23 E., S. 31, B. T.

A \_\_\_\_\_, \_\_\_\_\_ ins. diam., bears N. \_\_\_\_\_° W., \_\_\_\_\_ lks. dist., marked  
T. 13 N., R. 22 E., S. 36, B. T.

**CLOSING TOWNSHIP CORNERS.**

[See Plates V and VI.]

When more than one-half of all the township corners are stone corners, the descriptions in paragraphs 1 and 2, if the corners therein described are established, will be modified, as follows: Strike out "C. C., on S.;" After "marked", insert the words

"C. C., 3 N. on S.,  
2 W. on E., and  
3 W. on W. faces."

When, under the conditions above specified, the corner described in paragraph 1 is established, a stake may be driven in the east pit, and marked instead of the stone, and described as exemplified in the last clause of paragraph 6, page 26.

1. *Stone, with Pits and Mound of Earth.*

Set a \_\_\_\_\_ stone, \_\_\_\_\_ x \_\_\_\_\_ x \_\_\_\_\_ ins., \_\_\_\_\_ ins. in the ground, for closing cor. of (e. g.) Tps. 4 N., Rs. 2 and 3 W., marked C. C., on S.; with 6 grooves on S., E., and W. faces; dug pits, 30 x 24 x 12 ins., crosswise on each line, E. and W., 4 ft., and S. of stone, 8 ft. dist.; and raised a mound of earth, 5 ft. base, 2½ ft. high, S. of cor.

2. *Stone, with Mound of Stone.*

Set a \_\_\_\_\_ stone, \_\_\_\_\_ x \_\_\_\_\_ x \_\_\_\_\_ ins., \_\_\_\_\_ ins. in the ground, for closing cor. of (e. g.) Tps. 4 N., Rs. 2 and 3 W., marked C. C., on S.; with 6 grooves on S., E., and W. faces; and raised a mound of stone, 2 ft. base, 1½ ft. high, S. of cor. Pits impracticable.

3. *Stone, with Bearing Trees.*

Set a \_\_\_\_\_ stone, \_\_\_\_\_ x \_\_\_\_\_ x \_\_\_\_\_ ins., \_\_\_\_\_ ins. in the ground, for closing cor. of (e. g.) Tps. 4 N., Rs. 2 and 3 W., marked C. C., on S.; with 6 grooves on S., E., and W. faces; from which:

A \_\_\_\_\_, \_\_\_\_\_ ins. diam. bears S. \_\_\_\_\_° E., \_\_\_\_\_ lks. dist., marked

T. 4 N., R. 2 W., S. 6, B. T.

A \_\_\_\_\_, \_\_\_\_\_ ins. diam., bears S. \_\_\_\_\_° W., \_\_\_\_\_ lks. dist., marked

T. 4 N., R. 3 W., S. 1, B. T.

4. *Post, with Pits and Mound of Earth.*

Set a \_\_\_\_\_ post, 3 ft. long, 4 ins. sq., with marked stone (charred stake or quart of charcoal), 24 ins. in the ground, for closing cor. of (e. g.) Tps. 4N., Rs. 2 and 3 W., marked

C. C., T. 4 N. on S.,

R. 2 W., S. 6 on E., and

R. 3 W., S. 1 on W. faces; with 6 grooves on S., E., and W. faces; dug pits, 30 x 24 x 12 ins., crosswise on each line, E. and W., 4 ft., and S. of post 8 ft. dist.; and raised a mound of earth, 5 ft. base, 2½ feet high, S. of cor.

5. *Post, with Bearing Trees.*

Set a \_\_\_\_\_ post, 3 ft. long, 4 ins. sq., 24 ins. in the ground, for closing cor. of (e. g.) Tps. 4 N., Rs. 2 and 3 W., marked

C. C., T. 4 N. on S.,

R. 2 W., S. 6 on E., and

R. 3 W., S. 1 on W. faces; with 6 grooves on S., E., and W. faces; from which

A \_\_\_\_\_, \_\_\_\_\_ ins. diam., bears S. \_\_\_\_\_° E., \_\_\_\_\_ lks. dist., marked

T. 4 N., R. 2 W., S. 6, B. T.

A \_\_\_\_\_, \_\_\_\_\_ ins. diam., bears S. \_\_\_\_\_° W., \_\_\_\_\_ lks. dist., marked

T. 4 N., R. 3 W., S. 1, B. T.

6. *Mound of Earth, with Deposit, and Stake in Pit.*

Deposited a marked stone (charred stake or quart of charcoal), 12 ins. in the ground, for standard cor. of (e. g.) Tps 4 N., Rs. 2 and 3 W.; dug pits, 30 x 24 x 12 ins., crosswise on each line, S., E., and W. of cor., 5 ft. dist.; and raised a mound of earth, 5 ft. base, 2½ ft. high, over deposit.

In E. pit, drove a \_\_\_\_\_ stake 2 ft. long, 2 ins. sq., 12 ins. in the ground, marked

C. C., T. 4 N. on S.,

R. 2 W., S. 6 on E., and

R. 3 W., S. 1 on W. faces; with 6 grooves on S., E., and W. faces.

7. *Tree Corner, with Pits and Mound of Earth.*

A \_\_\_\_\_, \_\_\_\_\_ ins. diam., for closing cor. of (e. g.) Tps. 4 N., Rs. 2 and 3 W., I marked

C. C., T. 4 N. on S.,

R. 2 W., S. 6 on E., and

R. 3 W., S. 1 on W. sides; with 6 notches on S., E., and W.

sides; dug pits, 24 x 18 x 12 ins., crosswise on each line, S., E., and W. of cor., 5 ft. dist.; and raised a mound of earth, around tree.

8. *Tree Corner, with Bearing Trees.*

A \_\_\_\_\_, \_\_\_\_\_ ins. diam., for closing cor. of (e. g.) Tps. 4 N., Rs. 2 and 3 W., I marked

-27-

C. C., T. 4 N. on S.,

R. 2 W., S. 6 on E., and

R. 3 W., S. 1 on W. sides; with 6 notches on S., E., and W. sides; from which

A \_\_\_\_\_, \_\_\_\_\_ ins. diam., bears S. \_\_\_\_\_° E., \_\_\_\_\_ lks. dist., marked

T. 4 N., R. 2 W., S. 6, B. T.

A \_\_\_\_\_, \_\_\_\_\_ ins. diam., bears S. \_\_\_\_\_° W., \_\_\_\_\_ lks. dist., marked

T. 4 N., R. 3 W., S. 1, B. T.

9. *Connecting lines.*

All closing township corners on base lines or standard parallels, will be connected, by course and distance, with the nearest standard corner thereon; closing corners on all other lines, will be connected, in a similar manner, with the nearest township, section, or quarter section corner, or mile or half-mile monument, as existing conditions may require.

10. *Relative positions of Closing Corners, Pits, Mounds, and Bearing Trees.*

Any line, which by intersection with another surveyed line, determines the place for a closing corner, will be called a closing line; then in general, the mound and one pit of a closing corner will be placed on such "closing line," N., S., E., or W. of the closing corner, as prevailing conditions may require; while said mound and pit, with the two bearing trees (if used), will always be located on the same side of the line closed upon, and on which the other pits will be established, as directed in the foregoing descriptions, and illustrated on Plate VI.

11. *Positions and dimensions of Pits of Closing Corners on irregular boundaries.*

When a closing line intersects an irregular boundary at an angle less than 75°, and stone or post closing corners are established, the pit on the boundary adjoining the acute angle will be omitted, and the pit on the opposite side of the closing corner will have its dimensions increased, as follows: For a closing township corner, the enlarged pit will measure 42 x 36 x 12 ins.; for a closing section corner it will be 30 x 24 x 12 ins. (See Plate VI, figs. 2 and 3.)

12. *Township or Section interfering Closing Corners.*

When two closing lines, at right angle to each other, intersect an irregular boundary at points less than 8 feet apart, and stone or post corners are established, the pits, that under ordinary circumstances would be placed on the boundary,

will be omitted, and the pits on the closing lines will have their dimensions increased to 36 x 36 x 12 ins. (See Plate VI, fig. 4, at a and b.)

13. *Positions and dimensions of Pits and Mounds of interfering Closing Corners.*

When, under the conditions stated in paragraphs 11 and 12, the corners "Mound of Earth, with Deposits and Stake in Pit" are established, the pits on the boundary line will be omitted when the distance between the closing corners is less than 10 feet and greater than 4 feet, and the dimensions of the pits on the closing lines will be increased as directed in said paragraphs.

In case the distance between the closing corners is less than 4 feet, one mound, 5 ft. base, 2½ ft. high, will cover the deposits of both closing corners. (See Plate VI, fig. 4, at c, d, and e.)

-28-

**CORNERS COMMON TO FOUR TOWNSHIPS.**

[See Plate V.]

When more than one-half of all the corners of a township are stone corners, the descriptions in paragraphs 1 and 2, if the corners therein described are established, will be modified, as follows: After "marked", insert the words

"3 N. on N. E.,  
2 E. on S. E.,  
2 N. on S. W., and  
3 E. on N. W. faces;"

1. *Stone, with Pits and Mound of Earth.*

Set a \_\_\_\_\_ stone, \_\_\_\_\_ x \_\_\_\_\_ x \_\_\_\_\_ ins., \_\_\_\_\_ ins. in the ground, for cor. of (e. g.) Tps. 2 and 3 N., Rs. 2 and 3 W., marked with 6 notches on each edge; dug pits, 24 x 24 x 12 ins., on each line, N., E., and W., 4 ft., and S. of stone, 8 ft. dist.; and raised a mound of earth, 5 ft. base, 2½ ft. high, S. of cor.

2. *Stone, with Mound of Stone.*

Set a \_\_\_\_\_ stone, \_\_\_\_\_ x \_\_\_\_\_ x \_\_\_\_\_ ins., \_\_\_\_\_ ins. in the ground, for cor. of (e. g.) Tps. 2 and 3 N., Rs. 2 and 3 W., marked with 6 notches on each edge, and raised a mound of stone, 2 ft. base, 1½ ft. high, S. of cor. Pits impracticable.

3. *Stone, with Bearing Trees.*

Set a \_\_\_\_\_ stone, \_\_\_\_\_ x \_\_\_\_\_ x \_\_\_\_\_ ins., \_\_\_\_\_ ins. in the ground, for cor. of (e. g.) Tps. 2 and 3 N., Rs. 2 and 3 W., marked with 6 notches on each edge; from which  
A \_\_\_\_\_, \_\_\_\_\_ ins. diam., bears N. \_\_\_\_\_° E.,  
\_\_\_\_\_ lks. dist., marked

T. 3 N., R. 2 W., S. 31, B. T.

A \_\_\_\_\_, \_\_\_\_\_ ins. diam., bears S. \_\_\_\_\_° E., \_\_\_\_\_ lks. dist., marked

T. 2 N., R. 2 W., S. 6, B. T.

A \_\_\_\_\_, \_\_\_\_\_ ins. diam., bears S. \_\_\_\_\_° W., \_\_\_\_\_ lks. dist., marked

T. 2 N., R. 3 W., S. 1, B. T.

A \_\_\_\_\_, \_\_\_\_\_ ins. diam., bears N. \_\_\_\_\_° W., \_\_\_\_\_ lks. dist., marked

T. 3 N., R. 3 W., S. 36, B. T.

4. *Post, with Pits and Mound of Earth.*

Set a \_\_\_\_\_ post, 3 ft. long, 4 ins. sq., with marked stone (charred stake or quart of charcoal), 24 ins. in the ground, for cor. of (e. g.) Tps. 2 and 3 N., Rs. 2 and 3 W., marked

T. 3 N., S. 31 on N. E.,

R. 2 W., S. 6 on S. E.,

T. 2 N., S. 1 on S. W., and

R. 3 W., S. 36 on N. W. faces; with 6 notches on each edge; dug pits, 24 x 24 x 12 ins., on each line, N., E., and W., 4 ft., and S. of post, 8 ft. dist.; and raised a mound of earth, 5 ft. base, 2½ feet high, S. of cor.

5. *Post, with Bearing Trees.*

Set a \_\_\_\_\_ post, 3 ft. long, 4 ins. sq., 24 ins. in the ground, for cor. of (e. g.) Tps. 2 and 3 N., Rs. 2 and 3 W., marked

T. 3 N., S. 31 on N. E.,

R. 2 W., S. 6 on S. E.,

T. 2 N., S. 1 on S. W., and

-29-

R. 3 W., S. 36 on N. W., faces; with 6 notches on each edge; from which

A \_\_\_\_\_, \_\_\_\_\_ ins. diam., bears N. \_\_\_\_\_° E., \_\_\_\_\_ lks. dist., marked

T. 3 N., R. 2 W., S. 31, B. T.

A \_\_\_\_\_, \_\_\_\_\_ ins. diam., bears S. \_\_\_\_\_° E., \_\_\_\_\_ lks. dist., marked

T. 2 N., R. 2 W., S. 6, B. T.

A \_\_\_\_\_, \_\_\_\_\_ ins. diam., bears S. \_\_\_\_\_° W., \_\_\_\_\_ lks. dist., marked

T. 2 N., R. 3 W., S. 1, B. T.

A \_\_\_\_\_, \_\_\_\_\_ ins. diam., bears N. \_\_\_\_\_° W., \_\_\_\_\_ lks. dist., marked

T. 3 N., R. 3 W., S. 36, B. T.

6. *Mound of Earth, with Deposit, and Stake in Pit.*

Deposited a marked stone (charred stake or quart of charcoal), 12 ins. in the ground, for cor. of (e. g.) Tps. 2 and 3 N., Rs. 2 and 3 W.; dug pits 24 x 24 x 12 ins., on each line, N., S., E., and W. of cor., 5 ft. dist.; and raised a mound of earth, 5 ft. base, 2½ ft. high, over deposit.

In E. pit drove a \_\_\_\_\_ stake, 2 ft. long, 2 ins. sq., 12 ins. in the ground, marked

T. 3 N., S. 31 on N. E.,

R. 2 W., S. 6 on S. E.,

T. 2 N., S. 1 on S. W., and

R. 3 W., S. 36 on N. W. faces; with 6 notches on each edge.

7. *Tree Corner, with Pits and Mound of Earth.*

A \_\_\_\_\_, \_\_\_\_\_ ins. diam., for cor. of (e. g.) Tps. 2 and 3 N., Rs. 2 and 3 W., I marked

T. 3 N., S. 31 on N. E.,

R. 2 W., S. 6 on S. E.,

T. 2 N., S. 1 on S. W., and  
R. 3 W., S. 36 on N. W. sides; with 6 notches facing each cardinal point; dug pits, 24 x 18 x 12 ins., on each line, N., S., E., and W. of cor., 5 ft. dist.; and raised a mound of earth around tree.

### 8. Tree Corner, with Bearing Trees.

A \_\_\_\_\_, \_\_\_\_\_ ins. diam., for cor. of (e. g.) Tps. 2 and 3 N., Rs. 2 and 3 W., I marked

T. 3 N., S. 31 on N. E.,

R. 2 W., S. 6 on S. E.,

T. 2 N., S. 1 on S. W., and

R. 3 W., S. 36 on N. W. sides; with 6 notches facing each cardinal point; from which

A \_\_\_\_\_, \_\_\_\_\_ ins. diam., bears N. \_\_\_\_\_° E., \_\_\_\_\_ lks. dist., marked

T. 3 N., R. 2 W., S. 31, B. T.

A \_\_\_\_\_, \_\_\_\_\_ ins. diam., bears S. \_\_\_\_\_° E., \_\_\_\_\_ lks. dist., marked

T. 2 N., R. 2 W., S. 6, B. T.

A \_\_\_\_\_, \_\_\_\_\_ ins. diam., bears S. \_\_\_\_\_° W., \_\_\_\_\_ lks. dist., marked

T. 2 N., R. 3 W., S. 1, B. T.

A \_\_\_\_\_, \_\_\_\_\_ ins. diam., bears N. \_\_\_\_\_° W., \_\_\_\_\_ lks. dist., marked

T. 3 N., R. 3 W., S. 36, B. T.

## CORNERS COMMON TO TWO TOWNSHIPS ONLY.

[See Plates V and IX.]

*When more than one-half of all the corners of a township are stone corners, the descriptions in paragraphs 1 and 2, if the corners therein described are established, will be modified as follows:*

After "marked", insert the words:

"2 N. on S. W., and

7 W. on N. W. faces."

-30-

*When, under the conditions above specified, the corner described in paragraph 1 is established, a stake may be driven in the south pit and marked instead of the stone, and described as exemplified in the last clause of paragraph 6, below.*

### 1. Stone, with Pits and Mounds of Earth.

Set a \_\_\_\_\_ stone, \_\_\_\_\_ x \_\_\_\_\_ x \_\_\_\_\_ ins., \_\_\_\_\_ ins. in the ground, for cor. of (e. g.) Tps. 2 and 3 N., R. 7 W., on W. bdy. Tp. 3 N., R. 6 W., marked with 6 notches on N., and W. edges; dug pits 30 x 24 x 12 ins., on each line, N. and S., 4 ft., and W. of stone, 8 ft. dist.; and raised a mound of earth, 5 ft. base, 2½ ft. high, W. of cor.

### 2. Stone, with Mound of Stone.

Set a \_\_\_\_\_ stone, \_\_\_\_\_ x \_\_\_\_\_ x \_\_\_\_\_ ins., \_\_\_\_\_ ins. in the ground, for cor. of (e. g.) Tps. 2 and 3 N., R. 7 W., on W. bdy. Tp. 3 N., R. 6 W., marked with 6 notches on N., and W. edges; and raised a mound of stone, 2 ft. base, 1½ ft. high, W. of cor. Pits impracticable.

### 3. Stone, with Bearing Trees.

Set a \_\_\_\_\_ stone, \_\_\_\_\_ x \_\_\_\_\_ x \_\_\_\_\_ ins., \_\_\_\_\_ ins. in the ground, for cor. of (e. g.) Tps. 2 and 3 N., Rs. 5 and 6 W., on N. bdy. Tp. 2 N., R. 6 W., marked with 6 notches on N. and W. edges; from which

A \_\_\_\_\_, ins. diam., bears N. \_\_\_\_\_° E., \_\_\_\_\_ lks. dist., marked

T. 2 N., R. 5 W., S. 6, B. T.

A \_\_\_\_\_, \_\_\_\_\_ ins. diam., bears N. \_\_\_\_\_° W., \_\_\_\_\_ lks. dist., marked

T. 3 N., R. 6 W., S. 36, B. T.

### 4. Post, with Pits and Mound of Earth.

Set a \_\_\_\_\_ post, 3 ft. long, 4 ins. sq., with marked stone (charred stake or quart of charcoal), 24 ins. in the ground, for cor. of (e. g.) Tps. 2 and 3 N., Rs. 5 and 6 W., on N. bdy. Tp. 2 N., R. 6 W., marked

T. 2 N., R. 5 W., S. 6 on N. E., and

T. 3 N., R. 6 W., S. 36 on N. W. faces; with 6 notches on N. and W. edges; dug pits, 30 x 24 x 12 ins., on each line, E. and W., 4 ft., and N. of post, 8 ft. dist.; and raised a mound of earth, 5 ft. base, 2½ ft. high, N. of cor.

### 5. Post, with Bearing Trees.

Set a \_\_\_\_\_ post, 3 ft. long, 4 ins. sq., 24 ins. in the ground, for cor. of (e. g.) Tps. 2 and 3 N., R. 7 W., on W. bdy. Tp. 3 N., R. 6 W., marked

T. 2 N., R. 7 W., S. 1 on S. W., and

T. 3 N., R. 7 W., S. 36 on N. W. faces; with 6 notches on N. and W. edges; from which

A \_\_\_\_\_, \_\_\_\_\_ ins. diam., bears S. \_\_\_\_\_° W., lks. dist., marked

T. 2 N., R. 7 W., S. 1, B. T.

A \_\_\_\_\_, \_\_\_\_\_ ins. diam., bears N. \_\_\_\_\_° W., \_\_\_\_\_ lks. dist., marked

T. 3 N., R. 7 W., S. 36, B. T.

### 6. Mound of Earth, with Deposit, and Stake in Pit.

Deposited a marked stone (charred stake or quart of charcoal), 12 ins. in the ground, for cor. of (e. g.) Tps. 2 and 3 N., R. 7 W., on W. bdy. Tp. 3 N., R. 6 W.; dug pits, 30 x 24 x 12 ins., on each line, N., E., and W. of cor., 5 ft. dist.; and raised a mound of earth, 5 ft. base, 2½ ft. high, over deposit.

In S. pit drove a \_\_\_\_\_ stake, 2 ft. long, 2 ins. sq., 12 ins. in the ground, marked

T. 2 N., R. 7 W., S. 1 on S. W., and

T. 2 N., R. 7 W., S. 36 on N. W. faces; with 6 notches on N. and W. edges.

-31-

### 7. Tree Corner, with Pits and Mound of Earth.

A \_\_\_\_\_, \_\_\_\_\_ ins. diam., for cor. of (e. g.) Tps. 2 and 3 N., Rs. 5 and 6 W., on N. bdy. Tp. 2 N., R. 6 W., I marked

T. 2 N., R. 5 W. on N. E., and

T. 3 N., R. 6 W. on N. W. sides; with 6 notches facing N. and W.; dug pits 24 x 18 x 12 ins., crosswise on each line, N., E., and W. of cor., 5 ft. dist.; and raised a mound of earth, around tree.

A \_\_\_\_\_, \_\_\_\_\_ ins. diam., for cor. of (e. g.) Tps. 2 and 3 N., R. 7 W., on W. bdy. Tp. 3 N., R. 6 W., I marked

T. 2 N., R. 7 W., S. 1 on S. W., and

T. 3 N., R. 7 W., S. 36 on N. W., sides; with 6 notches facing N. and W.; from which

A \_\_\_\_\_, \_\_\_\_\_ ins. diam., bears S. \_\_\_\_\_° W., \_\_\_\_\_ lks. dist., marked

T. 2 N., R. 7 W., S. 1, B. T.

A \_\_\_\_\_, \_\_\_\_\_ ins. diam., bears N. \_\_\_\_\_° W., \_\_\_\_\_ lks. dist., marked

T. 3 N., R. 7 W., S. 36, B. T.

### CORNERS REFERRING TO ONE TOWNSHIP ONLY.

[See Plates V and IX.]

*When more than one-half of all corners of a township are stone corners, the descriptions in paragraphs 1 and 2, if the corners therein described are established, will be modified, as follows: After "marked", insert the words:*

"2 N., 6 W. on S. W. face."

*When, under the conditions above specified, the corner described in paragraph 1 is established, a stake may be driven in the south pit, and marked instead of the stone, and described as exemplified in the last clause of paragraph 6, page 32.*

#### 1. *Stone, with Pits and Mound of Earth.*

Set a \_\_\_\_\_ stone, \_\_\_\_\_ x \_\_\_\_\_ x \_\_\_\_\_ ins., \_\_\_\_\_ ins. in the ground, for N. E. cor. of (e. g.) Tp. 2 N., R. 6 W., marked with 6 notches on S. and W. edges; dug pits, 36 x 36 x 12 ins., on each line, S. and W. of stone, 8 ft. dist.; and raised a mound of earth, 5 ft. base, 2½ ft. high, S. W. of cor.

#### 2. *Stone, with Mound of Stone.*

Set a \_\_\_\_\_ stone, \_\_\_\_\_ x \_\_\_\_\_ x \_\_\_\_\_ ins., \_\_\_\_\_ ins. in the ground, for N. E. cor. of (e. g.) Tp. 2 N., R. 6 W., marked with 6 notches on S. and W. edges; and raised a mound of stone, 2 ft. base, 1½ ft. high, S. W. of cor. Pits impracticable.

#### 3. *Stone, with Bearing Tree.*

Set a \_\_\_\_\_ stone, \_\_\_\_\_ x \_\_\_\_\_ x \_\_\_\_\_ ins., \_\_\_\_\_ ins. in the ground for N. E. cor. of (e. g.) Tp. 2 N., R. 6 W., marked with 6 notches on S. and W. edges; from which

A \_\_\_\_\_, \_\_\_\_\_ ins. diam., bears S. \_\_\_\_\_° W., \_\_\_\_\_ lks. dist., marked

T. 2 N., R. 6 W., S. 1, B. T.

#### 4. *Post, with Pits and Mound of Earth.*

Set a \_\_\_\_\_ post, 3 ft. long, 4 ins. sq., with marked stone (charred stake or quart of charcoal), 24 ins. in the ground, for N. E. cor. of (e. g.) Tp. 2 N., R. 6 W., marked

T. 2 N., R. 5 W., S. 6 on N. E.,

S. 6 on S. E.,

T. 2 N., R. 6 W., S. 1 on S. W., and

S. 6 on N. W. faces; with 6 notches on S. and W. edges; dug pits, 36 x 36 x 12 ins., on each line, S. and W. of post, 8 ft. dist.; and raised a mound of earth, 5 ft. base, 2½ ft. high, S. W. of cor.

#### 5. *Post, with Bearing Tree.*

Set a \_\_\_\_\_ post, 3 ft. long, 4 ins. sq., 24 ins. in the ground, for S. W. cor. of (e. g.) Tp. 3 N., R. 6 W., marked

T. 3 N., R. 6 W., S. 31 on N. E.,

S. 1 on S. E.,

T. 2 N., R. 7 W., S. 1 on S. W., and

S. 1 on N. W., faces; with 6 notches on N. and E. edges; from which

A \_\_\_\_\_, \_\_\_\_\_ ins. diam., bears N. \_\_\_\_\_° E., \_\_\_\_\_ lks. dist., marked

T. 3 N., R. 6 W., S. 31, B. T.

#### 6. *Mound of Earth, with Deposit, and Stake in Pit.*

Deposited a marked stone (charred stake or quart of charcoal), 12 ins. in the ground, for S. W. cor. of (e. g.) T. 3 N., R. 6 W.; dug pits, 36 x 36 x 12 ins., on each line, N. and E. of cor., 5 ft. dist.; and raised a mound of earth, 5 ft. base, 2½ ft. high, over deposit.

In E. pit drove a \_\_\_\_\_ stake, 2 ft. long, 2 ins. sq., 12 ins. in the ground, marked

T. 3 N., R. 6 W., S. 31 on N. E.,

S. 1 on S. E.,

T. 2 N., R. 7 W., S. 1 on S. W., and

S. 1 on N. W. faces; with 6 notches on N. and E. edges.

#### 7. *Tree Corner, with Pits and Mound of Earth.*

A \_\_\_\_\_, \_\_\_\_\_ ins. diam., for S. W. cor. of (e. g.) Tp. 3 N., R. 6 W., I marked

T. 2 N., R. 6 W., S. 31 on N. E.,

S. 1 on S. E.,

T. 2 N., R. 7 W., S. 1 on S. W., and

S. 1 on N. W. sides; with 6 notches facing N. and E.; dug pits, 30 x 24 x 12 ins., crosswise on each line, N. and E. of cor., 5 ft. dist.; and raised a mound of earth, around tree.

#### 8. *Tree Corner, with Bearing Tree.*

A \_\_\_\_\_, \_\_\_\_\_ ins. diam., for S. E. cor. of (e. g.) Tp. 4 N., R. 6 W., I marked

S. 6 on N. E.,

T. 3 N., R. 5 W. S. 6 on S. E.,

S. 6 on S. W., and

T. 4 N., R. 6 W., S. 36 on N. W. sides; with 6 notches facing N. and W.; from which

A \_\_\_\_\_, \_\_\_\_\_ ins. diam., bears N. \_\_\_\_\_° W., \_\_\_\_\_ lks. dist., marked

T. 2 N., R. 6 W., S. 36, B. T.

[See Plates III and V.]

1. *Stone, with Pits and Mound of Earth.*

Set a \_\_\_\_\_ stone, \_\_\_\_\_ x \_\_\_\_\_ x \_\_\_\_\_ ins. in the ground, for standard cor. of (e. g.) secs. 31 and 32, marked S. C., on N.; with 5 grooves on E., and 1 groove on W. faces; dug pits, 24 x 18 x 12 ins., crosswise on

-33-

each line, E. and W., 3 ft., and N. of stone, 7 ft. dist.; and raised a mound of earth, 4 ft. base, 2 ft. high, N. of cor.

2. *Stone, with Mound of Stone.*

Set a \_\_\_\_\_ stone, \_\_\_\_\_ x \_\_\_\_\_ x \_\_\_\_\_ ins., \_\_\_\_\_ ins. in the ground, for stand. cor. of (e. g.) secs. 35 and 36, marked S. C., on N.; with 1 groove on E., and 5 grooves on W. faces; and raised a mound of stone, 2 ft. base, 1½ ft. high, N. of cor. Pits impracticable.

3. *Stone, with Bearing Trees.*

Set a \_\_\_\_\_ stone, \_\_\_\_\_ x \_\_\_\_\_ x \_\_\_\_\_ ins., \_\_\_\_\_ ins. in the ground, for standard cor. of (e. g.) secs. 33 and 34, marked S. C., on N.; with 3 grooves on E. and W. faces; from which

A \_\_\_\_\_, \_\_\_\_\_ ins. diam., bears N. \_\_\_\_\_° E., \_\_\_\_\_ lks. dist., marked

T. 13 N., R. 21 E., S. 34, B. T.

A \_\_\_\_\_, \_\_\_\_\_ ins. diam., bears N. \_\_\_\_\_° W., \_\_\_\_\_ lks. dist., marked

T. 13 N., R. 21 E., S. 33, B. T.

4. *Post, with Pits and Mound of Earth.*

Set a \_\_\_\_\_ post, 3 ft. long, 4 ins. sq., with marked stone (charred stake or quart of charcoal), 24 ins. in the ground, for standard cor. of (e. g.) secs. 32 and 33, marked

S. C., T. 13 N., R. 21 E. on N.,

S. 33 on E., and

S. 32 on W. faces; with 4 grooves on E., and 2 grooves on W. faces; dug pits, 24 x 18 x 12 ins., crosswise on each line, E. and W., 3 ft., and N. of post, 7 ft. dist.; and raised a mound of earth, 4 ft. base, 2 ft. high, N. of cor.

5. *Post, with Bearing Trees.*

Set a \_\_\_\_\_ post, 3 ft. long, 4 ins. sq., 24 ins. in the ground, for standard cor. of (e. g.) secs. 34 and 35, marked

S. C., T. 13 N., R. 21 on N.,

S. 35 on E., and

S. 34 on W. faces; with two grooves on E., and 4 grooves on W. faces; from which

A \_\_\_\_\_, \_\_\_\_\_ ins. diam., bears N. \_\_\_\_\_° E., \_\_\_\_\_ lks. dist., marked

T. 13 N., R. 21 E., S. 35, B. T.

A \_\_\_\_\_, \_\_\_\_\_ ins. diam., bears N. \_\_\_\_\_° W., \_\_\_\_\_ lks. dist., marked

6. *Mound of Earth, with Deposit, and Stake in Pit.*

Deposited a marked stone (charred stake or quart of charcoal), 12 ins. in the ground, for standard cor. of (e. g.) secs. 33 and 34; dug pits, 24 x 18 x 12 ins., crosswise on each line, N., E., and W. of cor., 5 ft. dist.; and raised a mound of earth, 4 ft. base, 2 ft. high, over deposit.

In E. pit drove a \_\_\_\_\_ stake, 2 ft. long, 2 ins. sq., 12 ins. in the ground, marked

S. C., T. 13 N., R. 22 E. on N.,

S. 34 on E., and

S. 33 on W. faces; with 3 grooves on E. and W. faces.

7. *Tree Corner, with Pits and Mound of Earth.*

A \_\_\_\_\_, \_\_\_\_\_ ins. diam., for standard cor. of (e. g.) secs. 31 and 32, I marked

S. C., T. 13 N., R. 22 E. on N.,

S. 32 on E., and

S. 31 on W. sides; with 5 notches on E., and 1 notch on W. sides;

-34-

dug pits, 18 x 18 x 12 ins., N., E., and W. of Cor., 4 ft. dist.; and raised a mound of earth, around tree.

8. *Tree Corner, with Bearing Trees.*

A \_\_\_\_\_, \_\_\_\_\_ ins. diam., for standard cor. of (e. g.) secs. 35 and 36, I marked

S. C., T. 13 N., R. 22 E. on N.,

S. 36 on E., and

S. 35 on W. sides; with 1 notch on E., and 5 notches on W. sides; from which

A \_\_\_\_\_, \_\_\_\_\_ ins. diam., bears N. \_\_\_\_\_° E., \_\_\_\_\_ lks. dist., marked

T. 13 N., R. 22 E., S. 36, B. T.

A \_\_\_\_\_, \_\_\_\_\_ ins. diam., bears N. \_\_\_\_\_° W., \_\_\_\_\_ lks. dist., marked

T. 13 N., R. 22 E., S. 35, B. T.

## CLOSING SECTION CORNERS.

[See Plates V and VI.]

1. *Stone, with Pits and Mound of Earth.*

Set a \_\_\_\_\_ stone, \_\_\_\_\_ x \_\_\_\_\_ x \_\_\_\_\_ ins., \_\_\_\_\_ ins. in the ground, for closing cor. of (e. g.) secs. 1 and 2, marked C. C., on S.; with 1 groove on E., and 5 grooves on W. faces; dug pits, 24 x 18 x 12 ins. crosswise on each line, E. and W., 3 ft., and S. of stone, 7 ft. dist.; and raised a mound of earth, 4 ft. base, 2 ft. high, S. of cor.

2. *Stone, with Mound of Stone.*

Set a \_\_\_\_\_ stone, \_\_\_\_\_ x \_\_\_\_\_ x \_\_\_\_\_ ins., \_\_\_\_\_ ins. in the ground, for closing cor. of (e. g.) secs. 3 and 4, marked C. C., on S.; with 3 grooves on E. and W. faces; and raised a mound of stone, 2 ft. base, 1½ ft. high, S. of cor. Pits impracticable.

3. *Stone, with Bearing Trees.*

Set a \_\_\_\_\_ stone, \_\_\_\_\_ x \_\_\_\_\_ x \_\_\_\_\_ ins. \_\_\_\_\_ ins. in the ground, for closing cor. of (e. g.) secs. 1 and 2, marked C. C., on S.; with 1 groove on E., and 5 grooves on and W. faces; from which

A \_\_\_\_\_, \_\_\_\_\_ ins. diam., bears S. \_\_\_\_\_° E., \_\_\_\_\_ lks. dist., marked

T. 4 N., R. 3 W., S. 1, B. T.

A \_\_\_\_\_, \_\_\_\_\_ ins. diam., bears S. \_\_\_\_\_° W., \_\_\_\_\_ lks. dist., marked

T. 4 N., R. 3 W., S. 2, B. T.

4. *Post, with Pits and Mound of Earth.*

Set a \_\_\_\_\_ post, 3 ft. long, 4 ins. sq., with marked stone (charred stake or quart of charcoal), 24 ins. in the ground, for closing cor. of (e. g.) secs. 1 and 2, marked

C. C., T. 4 N., R. 3 W. on S.,

S. 1 on E., and

S. 2 on W. faces; with 1 groove on E., and 5 grooves on W. faces; dug pits, 24 x 18 x 12 ins., crosswise on each line, E. and W., 3 ft., and S. of post, 7 ft. dist.; and raised a mound of earth, 4 ft. base, 2 ft. high, S. of cor.

5. *Post, with Bearing Trees.*

Set a \_\_\_\_\_ post, 3 ft. long, 4 ins. sq., 24 ins. in the ground, for closing cor. of (e. g.) secs. 1 and 2, marked

C. C., T. 4 N., R. 3 W. on S.,

S. 1 on E., and

-35-

S. 2 on W. faces; with 1 groove on E., and 5 grooves on W. faces; from which

A \_\_\_\_\_, \_\_\_\_\_ ins. diam., bears S. \_\_\_\_\_° E., \_\_\_\_\_ lks. dist., marked

T. 4 N., R. 3 W., S. 1, B. T.

A \_\_\_\_\_, \_\_\_\_\_ ins. diam., bears S. \_\_\_\_\_° W., \_\_\_\_\_ lks. dist., marked

T. 4 N., R. 3 W., S. 2, B. T.

6. *Mound of Earth, with Deposit, and Stake in Pit.*

Deposited a marked stone (charred stake or quart of charcoal), 12 ins. in the ground, for closing cor. of (e. g.) secs. 3 and 4; dug pits, 24 x 18 x 12 ins., crosswise on each line, S., E., and W. of cor., 4 ft. dist.; and raised a mound of earth, 4 ft. base, 2 ft. high, over deposit.

In E. pit drove a \_\_\_\_\_ stake, 2 ft. long, 2 ins. sq., 12 ins. in the ground, marked

C. C., T. 4 N., R. 3 W. on S.,

S. 3. on E., and

S. 4. on W. faces; with 3 grooves on E. and W. faces.

7. *Tree Corner, with Pits and Mound of Earth*

A \_\_\_\_\_, \_\_\_\_\_ ins. diam., for closing cor. of (e. g.) secs. 1 and 2, I marked

C. C., T. 4 N., R. 3 W. on S.,

S. 1 on E., and S. 2 on W. sides; with 1 notch on E., and 5 notches on W. sides; dug pits, 18 x 18 x 12 ins., S., E., and W. of cor., 5 ft. dist.; and raised a mound of earth around tree.

8. *Tree Corner, with Bearing Trees.*

A \_\_\_\_\_, \_\_\_\_\_ ins. diam., for closing cor. (e. g.) secs. 1 and 2, I marked

C. C., T. 4 N., R. 3 W. on S.,

S. 1 on E., and

S. 2 on W. sides; with 1 notch on E., and 5 notches on W. sides; from which

A \_\_\_\_\_, \_\_\_\_\_ ins., diam., bears S. \_\_\_\_\_° E., \_\_\_\_\_ lks. dist., marked

T. 4 N., R. 3 W., S. 1, B. T.

A \_\_\_\_\_, \_\_\_\_\_ ins. diam., bears S. \_\_\_\_\_° W., \_\_\_\_\_ lks. dist., marked

T. 4 N., R. 3 W., S. 2, B. T.

9. All closing section corners, or base lines or standard parallels, will be connected by course and distant with the nearest standard corner thereon. (See paragraphs 5 and 9, page 55.)

**CORNERS COMMON TO FOUR SECTIONS.**

[See Plates V and IX.]

When more than one-half of all the corners in a township are stone corners, the descriptions in paragraphs 1 and corners therein described are established for cor. of secs. 15, 16, 21 and 22, will be modified as follows: after "marked," insert the words

"4 N. on N.E., and

3 W. on S.E. face."

When, under the conditions above specified, the corner described in paragraph 1 is established a stake may be driven in the southeast pit, and marked instead of the stone, and described as exemplified in the last clause of paragraph 6, page 37.

1. *Stone, with Pits and Mound of Earth.*

Set a \_\_\_\_\_ stone, \_\_\_\_\_ x \_\_\_\_\_ x \_\_\_\_\_ ins., \_\_\_\_\_ ins. in the ground, for cor. of (e. g.) secs. 14, 15, 22, and 23 [Tp. 4 N., R. 3 W.]<sup>9</sup>, marked with 3 notches on S.

-36-

and E. edges; dug pits, 18 x 18 x 12 ins., in each sec. 5½ ft. dist.; and raised a mound of earth, 4 ft. base, 2 ft. high, W. of cor.

2. *Stone, with Mound of Stone.*

Set a \_\_\_\_\_ stone, \_\_\_\_\_ x \_\_\_\_\_ x \_\_\_\_\_ ins., \_\_\_\_\_ ins. in the ground, for cor. of (e. g.) secs. 14, 15, 22, and 23 [Tp. 4 N., R. 3 W.]<sup>9</sup>, marked with 3 notches on S. and E. edges; and raised a mound of stone, 2 ft. base, 1½ ft. high, W. of cor. Pits impracticable.

3. *Stone, with Bearing Trees.*

9. When writing these descriptions in the field notes, the angular brackets and the enclosed letters and figures will be omitted.

Set a \_\_\_\_\_ stone, \_\_\_\_\_ x \_\_\_\_\_ x \_\_\_\_\_ ins., \_\_\_\_\_ ins. in the ground, for cor. of (e. g.) secs. 9, 10, 15, and 16, marked with 4 notches on S., and 3 notches on E. edges; from which

A \_\_\_\_\_, \_\_\_\_\_ ins. diam., bears N. \_\_\_\_\_° E., \_\_\_\_\_ lks. dist., marked  
T. 2 N., R. 2 W., S. 10, B. T.

A \_\_\_\_\_, \_\_\_\_\_ ins. diam., bears S. \_\_\_\_\_° E., \_\_\_\_\_ lks. dist., marked  
T. 2 N., R. 2 W., S. 15, B. T.

A \_\_\_\_\_, \_\_\_\_\_ ins. diam., bears S. \_\_\_\_\_° W., \_\_\_\_\_ lks. dist., marked  
T. 2 N., R. 2 W., S. 16, B. T.

A \_\_\_\_\_, \_\_\_\_\_ ins. diam., bears N. \_\_\_\_\_° W., \_\_\_\_\_ lks. dist., marked  
T. 2 N., R. 2 W., S. 9, B. T.

#### 4. Post, with Pit and Mound of Earth.

Set a \_\_\_\_\_ post, 3 ft. long, 4 ins. sq., with marked stone (charred stake or quart of charcoal), 24 ins. in the ground, for cor. of (e. g.) secs. 15, 16, 21, and 22, marked

T. 2 N., S. 15 on N. E.,  
R. 2 W., S. 22 on S. E.,  
S. 21 on S. W., and  
S. 16 on N. W. faces with 3 notches on S. and E. edges; dug pits, 18 x 18 x 12 ins., in each sec., 5½ ft. dist.; and raised a mound of earth, 4 ft. base, 2 ft. high, W. of cor.

#### 5. Post, with Bearing Trees.

Set a \_\_\_\_\_ post, 3 ft. long, 4 ins. sq., 24 ins. in the ground for cor. of (e. g.) secs. 25, 26, 35 and 36, marked

T. 2 N., S. 25 on N. E.,  
R. 2 W., S. 36 on S. E.,  
S. 35 on S. W., and  
S. 26 on N. W. faces; with 1 notch on S. and E. edges; from which

A \_\_\_\_\_, \_\_\_\_\_ ins. diam., bears N. \_\_\_\_\_° E., \_\_\_\_\_ lks. dist., marked  
T. 2 N., R. 2 W., S. 25, B. T.

A \_\_\_\_\_, \_\_\_\_\_ ins. diam., bears S. \_\_\_\_\_° E., \_\_\_\_\_ lks. dist., marked  
T. 2 N., R. 2 W., S. 36, B. T.

A \_\_\_\_\_, \_\_\_\_\_ ins. diam., bears S. \_\_\_\_\_° W., \_\_\_\_\_ lks. dist., marked  
T. 2 N., R. 2 W., S. 35, B. T.

A \_\_\_\_\_, \_\_\_\_\_ ins. diam., bears N. \_\_\_\_\_° W., \_\_\_\_\_ lks. dist., marked  
T. 2 N., R. 2 W., S. 26, B. T.

#### 6. Mound, with Deposit, and Stake in Pit.

Deposited a marked stone (charred stake or quart of charcoal), 12 ins. in the ground, for cor. of (e. g.) secs. 25, 26, 35 and 36; dug pits, 18 x 18 x 12 ins., in each sec., 4 ft. dist.; and raised a mound of earth, 4 ft. base, 2 ft. high, over deposit.

-37-

In S. E. pit drove a \_\_\_\_\_ stake, 2 ft. long, 2 ins. sq., 12 ins. in the ground, marked

T. 2 N., S. 25 on N. E.,  
R. 2 W., S. 36 on S. E.,  
S. 35 on S. W., and  
S. 26 on N. W. faces; with 1 notch on S. and E. edges.

#### 7. Tree Corner, with Pits and Mound of Earth.

A \_\_\_\_\_, \_\_\_\_\_ ins. diam., for cor. of (e. g.) secs. 29, 30, 31, and 32, I marked

T. 2 N., S. 29 on N. E.,  
R. 2 W., S. 32 on S. E.,  
S. 31 on S. W., and  
S. 30 on N. W. sides; with 1 notch on S., and 5 notches on E. sides; dug pits, 18 x 18 x 12 ins., in each sec., 5 ft. dist.; and raised a mound of earth around tree.

#### 8. Tree Corner, with Bearing Trees.

A \_\_\_\_\_, \_\_\_\_\_ ins. diam., for cor. of (e. g.) secs. 5, 6, 7, and 8, I marked

T. 2 N., S. 5 on N. E.,  
R. 2 W., S. 8 on S. E.,  
S. 7 on S. W., and S. 6 on N. W. sides; with 5 notches on S. and E. sides; from which

A \_\_\_\_\_, \_\_\_\_\_ ins. diam., bears N. \_\_\_\_\_° E., \_\_\_\_\_ lks. dist., marked  
T. 2 N., R. 2 W., S. 5, B. T.

A \_\_\_\_\_, \_\_\_\_\_ ins. diam., bears S. \_\_\_\_\_° E., \_\_\_\_\_ lks. dist., marked  
T. 2 N., R. 2 W., S. 8, B. T.

A \_\_\_\_\_, \_\_\_\_\_ ins. diam., bears S. \_\_\_\_\_° W., \_\_\_\_\_ lks. dist., marked  
T. 2 N., R. 2 W., S. 7, B. T.

A \_\_\_\_\_, \_\_\_\_\_ ins. diam., bears N. \_\_\_\_\_° W., \_\_\_\_\_ lks. dist., marked  
T. 2 N., R. 2 W., S. 6, B. T.

### SECTION CORNERS COMMON TO TWO SECTIONS ONLY.

[See Plates V and VI.]

When more than one-half of all the corners in a township are stone corners, the descriptions in paragraphs 1 and 2, if the corners therein described are established near cor. of secs. 15, 16, 21, and 22, will be modified, as follows:

After "marked", insert the words  
"3 N. on S. W., and  
7 W. on N. W. faces;"

When, under the conditions above specified, the corner described in paragraph 1 is established, a stake may be driven in the southwest pit, and marked instead of the stone, and described as exemplified in the last clause of paragraph 6, page 38.

#### 1. Stone, with Pits and Mound of Earth.

Set a \_\_\_\_\_ stone, \_\_\_\_\_ x \_\_\_\_\_ x \_\_\_\_\_ ins., \_\_\_\_\_ ins. in the ground, for cor. of (e. g.)<sup>10</sup> secs. 25 and 36 [Tp. 3 N., R. 7 W.],<sup>11</sup> marked with 5 notches on N., and 1 notch on S. edges; dug pits, 24 x 24 x 12 ins. in each sec., 6 ft. dist.; and raised a mound of earth, 4 ft. base, 2 ft. high, W. of cor.



2. *Stone, with Mound of Stone.*

Set a \_\_\_\_\_ stone, \_\_\_\_\_ x \_\_\_\_\_ x \_\_\_\_\_ ins., \_\_\_\_\_ ins. in the ground, for cor. of (e.g.)<sup>12</sup> secs. 15 and 22 [Tp. 3 N., R. 7 W.],<sup>11</sup> marked with 3 notches on N., and S. edges; and raised a mound of stone, 2 ft. base, 1½ ft. high, W. of cor. Pits impracticable.

3. *Stone, with Bearing Trees.*

Set a \_\_\_\_\_ stone, \_\_\_\_\_ x \_\_\_\_\_ x \_\_\_\_\_ ins., \_\_\_\_\_ ins. in the ground, for cor. of (e.g.)<sup>13</sup> secs. 28 and 29, marked with 4 notches on E. edge; from which

A \_\_\_\_\_, \_\_\_\_\_ ins. diam., bears N. \_\_\_\_\_° E., \_\_\_\_\_ lks. dist., marked

T. 3 N., R. 7 W., S. 28, B. T.

A \_\_\_\_\_, \_\_\_\_\_ ins. diam., bears N. \_\_\_\_\_° W., \_\_\_\_\_ lks. dist., marked

T. 3 N., R. 7 W., S. 29, B. T.

4. *Post, with Pits and Mound of Earth.*

Set a \_\_\_\_\_ post, 3 ft. long, 4 ins. sq., with marked stone (charred stake or quart of charcoal), 24 ins. in the ground, for cor. of (e. g.) 33 and 34,<sup>14</sup> marked

T. 2 N., S. 34 on N. E., and

R. 6 W., S. 33 on N. W. faces; with three notches on E. and W. edges; dug pits, 24 x 24 x 12 ins., in each sec., 6 ft. dist., and raised a mound of earth, 4 ft. base, 2 ft. high, N. of cor.

5. *Post, with Bearing Trees:*

Set a \_\_\_\_\_ post, 3 ft. long, 4 ins. sq., 24 ins. in the ground, for cor. of (e. g.) secs. 24 and 25,<sup>15</sup> marked

T. 3 N., S. 25 on S. W., and

R. 5 W., S. 24 on N. W. faces; with 4 notches on N., and 2 notches on S. edges; from which

A \_\_\_\_\_, \_\_\_\_\_ ins. diam., bears S. \_\_\_\_\_° W., \_\_\_\_\_ lks. dist., marked

T. 3 N., R. 5 W., S. 25, B. T.

A \_\_\_\_\_, \_\_\_\_\_ ins. diam., bears N. \_\_\_\_\_° W., \_\_\_\_\_ lks. dist., marked

T. 3 N., R. 5 W., S. 24, B. T.

6. *Mound of Earth, with Deposit, and Stake in Pit.*

Deposited a marked stone (charred stake or quart of charcoal), 12 ins. in the ground, for cor. of (e. g.) secs. 13 and 24;<sup>16</sup> dug pits 24 x 24 x 12 ins., in each sec., 4 ft. dist.; and raised a mound of earth, 4 ft. base, 2 ft. high, over deposit.

In S. W. pit drove a \_\_\_\_\_ stake, 2 ft. long, 2 ins. sq., 12 ins. in the ground, marked

T. 2 N., S. 24 on S. W., and

R. 6 W., S. 13 on N. W. faces, with 3 notches on N. and S. edges.

7. *Tree Corner, with Pits and Mound of Earth.*

A \_\_\_\_\_, \_\_\_\_\_ ins. diam., for cor. of (e. g.) secs. 24 and 25,<sup>17</sup> I marked

T. 3 N., S. 25 on S. W. and

R. 6 W., S. 24 on N. W. sides; with 4 notches on N. and S.

sides; dug pits, 18 x 18 x 12 ins., in each sec., 5 ft. dist.; and raised a mound of earth around tree.

8. *Tree Corner, with Bearing Trees.*

A \_\_\_\_\_, \_\_\_\_\_ ins. diam., for cor. of (e. g.) secs. 22 and 27,<sup>18</sup> I marked

T. 3 N., S. 27 on S. W., and

R. 7 W., S. 22 on N. W. sides; with 4 notches on N., and 2 notches on S. sides; from which

A \_\_\_\_\_, \_\_\_\_\_ ins. diam., bears S. \_\_\_\_\_° W., \_\_\_\_\_ lks. dist., marked

T. 3 N., R. 7 W., S. 27, B. T.

A \_\_\_\_\_, \_\_\_\_\_ ins. diam., bears N. \_\_\_\_\_° W., \_\_\_\_\_ lks. dist., marked

T. 3 N., R. 7 W., S. 22, B. T.

**SECTION CORNERS REFERRING TO ONE SECTION ONLY.**

[See Plates V and IX.]

*When more than one-half of all corners in a township are stone corners, the descriptions in paragraphs 1 and 2, if the corners therein described, are established near the place for cor. of secs. 15, 16, 21, and 22, will be modified, as follows: After "marked", insert the words:*

"2 N., 5 W. on N. E. face,"

*When, under the conditions above specified, the corner described in paragraph 1 is established, a stake may be driven in the pit, and marked instead of the stone, and described as exemplified in the last clause of paragraph 6, page 40.*

1. *Stone, with Pit and Mound of Earth.*

Set a \_\_\_\_\_ stone, \_\_\_\_\_ x \_\_\_\_\_ x \_\_\_\_\_ ins., \_\_\_\_\_ ins. in the ground, for S. W. cor. of (e. g.) sec. 12 [Tp. 2 N., R. 5 W.],<sup>18</sup> marked with 1 notch on E. edge; dug a pit, 36 x 36 x 12 ins., in the sec., 8 ft. dist.; and raised a mound of earth, 4 ft. base, 2 ft. high, N. E. of cor.

2. *Stone, with Mound of Stone.*

Set a \_\_\_\_\_ stone, \_\_\_\_\_ x \_\_\_\_\_ x \_\_\_\_\_ ins., \_\_\_\_\_ ins. in the ground, for S. W. cor. of (e. g.) sec. 12 [Tp. 2

10. The corner established on the range line and described in paragraph 1, will have notches to indicate the distances to the N. E. and S. E. corners of the township. See plate V, fig. 18; and Plate IX, Tp. 3 N., R. 7 W.

11. When writing descriptions of corners similar to those described in paragraphs 1 and 2, the angular brackets and the inclosed letters and figures, will be omitted.

12. The corner established on a sectional guide meridian and described in paragraph 2, will have notches like the corresponding corner on a range line. See Plate IX, Tp. 3 N., R. 7 W.

13. See Plate IX, N. bdy., sec. 32, Tp. 3 N., R. 7 W.

14. See Plate IX, Tp. 2 N., R. 6 W.

15. Tp. 3 N., R. 5 W.

16. Tp. 2 N., R. 6 W.

17. On range line; see Plate IX; Tp. 3 N., R. 6 W.

18. On sectional guide meridian; see Plate IX, Tp. 3 N., R. 7 W.

N., R. 5 W.],<sup>19</sup> marked with 1 notch on E. edge; and raised a mound of stone, 2 ft. base, 1½ ft. high, N. E. of cor.

3. *Stone, with Bearing Tree.*

Set a \_\_\_\_\_ stone, \_\_\_\_\_ x \_\_\_\_\_ x \_\_\_\_\_ ins., \_\_\_\_\_ ins. in the ground, for S. W. cor. of (e. g.) sec. 12, marked with 1 notch on E. edge; from which

A \_\_\_\_\_, \_\_\_\_\_ ins. diam., bears N. \_\_\_\_\_° E., \_\_\_\_\_ lks. dist., marked  
T. 2 N., R. 5 W., S. 12, B. T.

4. *Post, with Pit and Mound of Earth.*

Set a \_\_\_\_\_ post, 3 ft. long, 4 ins. sq., with marked stone (charred stake or quart of charcoal), 24 ins. in the ground, for N. W. cor. of (e. g.) sec. 10;<sup>20</sup> marked

T. 3 N., S. 9 on N. E.,  
R. 5 W., S. 10 on S. E.,  
S. 9 on S. W., and  
S. 9 on N. W. faces; with 5 notches on S. and 3 notches on E. edges; dug a pit, 36 x 36 x 12 ins., in the sec., 8 ft. dist.; and raised a mound of earth, 4 ft. base, 2 ft. high, S. E. of cor.

-40-

5. *Post, with Bearing Tree.*

Set a \_\_\_\_\_ post, 3 ft. long, 4 ins. sq., 24 ins. in the ground, for S. W. cor. of (e. g.) sec. 12;<sup>21</sup> marked

T. 2 N., S. 12 on N. E.,  
R. 5 W., S. 13 on S. E.,  
S. 13 on S. W., and  
S. 13 on N. W. faces; with 1 notch on E. edge; from which  
A \_\_\_\_\_, \_\_\_\_\_ ins. diam., bears N. \_\_\_\_\_° E., \_\_\_\_\_ lks. dist., marked  
T. 2 N., R. 5 W., S. 12, B. T.

6. *Mound of Earth, with Deposit and Stake in pit.*

Deposited a marked stone (charred stake or quart of charcoal), 12 ins. in the ground, for N. W. cor. of (e. g.) sec. 10;<sup>15</sup> dug a pit, 36 x 36 x 12 ins. in the sec., 5 ft. dist.; and raised a mound of earth, 4 ft. base, 2 ft. high, over deposit.

In the pit drove a \_\_\_\_\_ stake, 2 ft. long, 2 ins. sq., 12 ins. in the ground, marked

T. 3 N., S. 9 on N. E.,  
R. 5 W., S. 10 on S. E.,  
S. 9 on S. W., and  
S. 9 on N. W. faces; with 5 notches on S., and 3 notches on E. edges.

7. *Tree Corner, with Pits and Mound of Earth.*

A \_\_\_\_\_, \_\_\_\_\_ ins. diam., for S. W. cor. of (e. g.) sec. 12,<sup>21</sup> I marked

T. 2 N., S. 12 on N. E.,  
R. 5 W., S. 13 on S. E.,  
S. 13 on S. W., and  
S. 13 on N. W. sides, with 1 notch on E. side; dug a pit, 24 x 24 x 12 ins., in the sec., 5 ft. dist.; and raised a mound of earth around tree.

8. *Tree Corner, with Bearing Trees.*

A \_\_\_\_\_, \_\_\_\_\_ ins. diam., for N. W. cor. of (e. g.) sec. 10, I marked

T. 3 N., S. 9 on N. E.,  
R. 5 W., S. 10 on S. E.,  
S. 9 on S. W., and  
S. 9 on N. W., sides; with 5 notches on S., and 3 notches on E. sides; from which

A \_\_\_\_\_, \_\_\_\_\_ ins. diam., bears S. \_\_\_\_\_° E., \_\_\_\_\_ lks. dist., marked  
T. 3 N., R. 5 W., S. 10, B. T.

**QUARTER SECTION CORNERS.**

[See Plates V and VI.]

1. *Stone, with Pits and Mound of Earth.*

Set a \_\_\_\_\_ stone, \_\_\_\_\_ x \_\_\_\_\_ x \_\_\_\_\_ ins., \_\_\_\_\_ ins. in the ground, for ¼ sec. cor. [(e. g.) bet. secs. 14 and 23],<sup>22</sup> marked ¼, on N. face; dug pits, 18 x 18 x 12 ins., E. and W. of stone, 3 ft. dist.; and raised a mound of earth, 3½ ft. base, 1½ ft. high, N. of cor.

-41-

2. *Stone, with Mound of Stone.*

Set a \_\_\_\_\_ stone, \_\_\_\_\_ x \_\_\_\_\_ x \_\_\_\_\_ ins., \_\_\_\_\_ ins. in the ground, for ¼ sec. cor. [(e. g.) bet. secs. 14 and 15],<sup>22</sup> marked ¼ on W. face; and raised a mound of stone, 2 ft. base, 1½ ft. high, W. of cor. Pits impracticable.

3. *Stone, with Bearing Trees.*

Set a \_\_\_\_\_ stone, \_\_\_\_\_ x \_\_\_\_\_ x \_\_\_\_\_ ins., \_\_\_\_\_ ins. in the ground, for ½ sec. cor. [(e. g.) bet. secs. 16 and 17],<sup>22</sup> marked ½, on W. face; from which  
A \_\_\_\_\_, \_\_\_\_\_ ins. diam., bears N. \_\_\_\_\_° E., \_\_\_\_\_ lks. dist., marked

¼ S., B. T.

A \_\_\_\_\_, \_\_\_\_\_ ins. diam., bears N. \_\_\_\_\_° W., \_\_\_\_\_ lks. dist., marked

¼ S., B. T.

4. *Post, with Pits and Mound of Earth.*

Set a \_\_\_\_\_ post, 3 ft. long, 3 ins. sq., with marked stone (charred stake or quart of charcoal), 24 ins. in the ground, for ¼ sec. cor. [(e. g.) bet. secs. 4 and 9],<sup>22</sup> marked ¼ S., on N. face; dug pits 18 x 18 x 12 ins., E. and W. of post, 3 ft. dist.; and raised a mound of earth, 3½ ft. base, 1½ ft. high, N. of cor.

5. *Post, with Bearing Trees.*

15. Tp. 3 N., R. 5 W.

19. When writing descriptions of corners similar to those described in paragraphs 1 and 2, the angular brackets and the included letters and figures will be omitted. See Plate IX.

20. See Plate IX; Tp. 3 N., R. 5 W.

21. See Plate IX; Tp. 2 N., R. 5 W.

22. When writing descriptions of ¼ section corners, the angular brackets and the letters and figures they inclose, will be omitted. See paragraphs 9, 10, and 11, pages 41, 42.

Set a \_\_\_\_\_ post, 3 ft. long, 3 ins. sq., 24 ins. in the ground, for  $\frac{1}{4}$  sec. cor. [(e. g.) bet. secs. 21 and 22],<sup>22</sup> marked  $\frac{1}{4}$  S., on W. face; from which

A \_\_\_\_\_, \_\_\_\_\_ ins. diam., bears S. \_\_\_\_\_° E., \_\_\_\_\_ lks. dist., marked  $\frac{1}{4}$  S., B. T.

A \_\_\_\_\_, \_\_\_\_\_ ins. diam., bears S. \_\_\_\_\_° W., \_\_\_\_\_ lks. dist., marked  $\frac{1}{4}$  S., B. T.

#### 6. Mound, with Deposit and Stake in Pit.

Deposited a marked stone (charred stake or quart of charcoal), 12 ins. in the ground, for  $\frac{1}{4}$  sec. cor. [(e. g.) bet. secs. 21 and 28];<sup>22</sup> dug pits, 18 x 18 x 12 ins., E. and W. of cor., 4 ft. dist.; and raised a mound of earth, 3½ ft. base, 1½ ft. high, over deposit.

In E. pit drove a \_\_\_\_\_ stake, 2 ft. long, 2 ins. sq., 12 ins. in the ground, marked  $\frac{1}{4}$  S. on N. face.

#### 7. Tree Corner, with Pits and Mound of Earth.

A \_\_\_\_\_, \_\_\_\_\_ ins. diam., for  $\frac{1}{4}$  sec. cor. [(e. g.) bet. secs. 7 and 8],<sup>22</sup> I marked  $\frac{1}{4}$  S., on W. side; dug pits, 18 x 18 x 12 ins., N. and S. of cor., 4 ft. dist.; and raised a mound of earth around tree.

#### 8. Tree Corner, with Bearing Trees.

A \_\_\_\_\_, \_\_\_\_\_ ins. diam., for  $\frac{1}{4}$  sec. cor. [(e. g.) bet. secs. 20 and 29],<sup>22</sup> I marked  $\frac{1}{4}$  S., on N. side; from which

A \_\_\_\_\_, \_\_\_\_\_ ins. diam., bears N. \_\_\_\_\_° W., \_\_\_\_\_ lks. dist., marked  $\frac{1}{4}$  S., B. T.

A \_\_\_\_\_, \_\_\_\_\_ ins. diam., bears S. \_\_\_\_\_° W., \_\_\_\_\_ lks. dist., marked  $\frac{1}{4}$  S., B. T.

#### 9. Pits and Mounds of Quarter Section Corners.

On *meridional* lines, the pits will be dug N. and S., and the mound will be placed on the *west* side of the corner; on *latitudinal* lines, the pits will be located E. and W., and the mound will be built on the *north* side of the corner. See Plate VI.

-42-

#### 10. Markings on Quarter Section Corners.

On *meridional* lines, the markings will be placed on the *west* side and on *latitudinal* lines, on the *north* side of the stone, post, or other corner.

#### 11. Stakes in Pits of Quarter Section Corners.

On *meridional* lines the stakes will be driven in the S. pit, and on *latitudinal* lines, in the E. pit.

### STANDARD QUARTER SECTION CORNERS.

[See Plate V and VI.]

All standard quarter section corners, on base lines or standard parallels, will have the letters S. C. (for standard cor-

ner), precede the marking " $\frac{1}{4}$ " or " $\frac{1}{4}$  S.," as the case may be; such corners will be established in all other respects like other quarter section corners.

When bearing trees are described for standard quarter section corners, each tree will be marked, S. C.,  $\frac{1}{4}$  S., B. T.

### QUARTER SECTION CORNERS COMMON TO TWO QUARTERS OF ONE SECTION.

These corners will be similar in all respects to those that are common to four quarters of two sections. See notes on Plates VII and VIII.

### MEANDER CORNERS.

[See Plates V and VI.]

#### 1. Stone, with Pit and Mound of Earth.

Set a \_\_\_\_\_ stone, \_\_\_\_\_ x \_\_\_\_\_ x \_\_\_\_\_ ins. \_\_\_\_\_ ins. in the ground for meander cor. of (e. g.) fracl. secs. 26 and 35,<sup>23</sup> marked

M. C. on E. face; with 1 groove on S. face; dug a pit,<sup>23</sup> 36 x 36 x 12 ins., 8 ft. W. of stone; and raised a mound of earth, 4 ft. base, 2 ft. high, W. of cor.<sup>23</sup>

#### 2. Stone, with Mound of Stone.

Set a \_\_\_\_\_ stone, \_\_\_\_\_ x \_\_\_\_\_ x \_\_\_\_\_ ins., \_\_\_\_\_ ins. in the ground, for meander cor. of (e. g.) fracl. secs. 17 and 18,<sup>24</sup> marked

M. C. on S. face; with 5 grooves on E. face; and raised a mound of stone, 2 ft. base, 1½ ft. high, N. of cor. Pits impracticable.

#### 3. Stone, with Bearing Trees.

Set a \_\_\_\_\_ stone \_\_\_\_\_ x \_\_\_\_\_ x \_\_\_\_\_ ins., \_\_\_\_\_ ins. in the ground, for meander cor. of (e. g.) fracl. secs. 26 and 35, with 1 groove on S. face;<sup>24</sup> marked:

M. C. on W. face; from which

A \_\_\_\_\_, \_\_\_\_\_ ins., diam., bears N. \_\_\_\_\_° E., \_\_\_\_\_ lks. dist., marked

T. 15 N., R. 20 E., S. 26, M. C. B. T.

A \_\_\_\_\_, \_\_\_\_\_ ins., diam., bears S. \_\_\_\_\_° C. \_\_\_\_\_ lks., dist., marked

T. 15 M., R. 20 E., S. 35, M. C. B. T.

#### 4. Post, with Pit and Mound of Earth.

Set a \_\_\_\_\_ post, 3 ft. long, 4 ins. sq., with marked stone (charred stake or quart of charcoal), 24 ins. in the ground, for meander cor. of (e. g.) fracl. secs. 19 and 20,<sup>24</sup> marked

M. C. on N.,

22. When writing descriptions of  $\frac{1}{4}$  section corners, the angular brackets and the letters and figures they inclose, will be omitted. See paragraphs 9, 10, and 11, pages 41, 42.

23. See page 56, and paragraphs 9 and 10, pages 43, 44.

24. See Plate IV, and pages 192, 209 and 210.

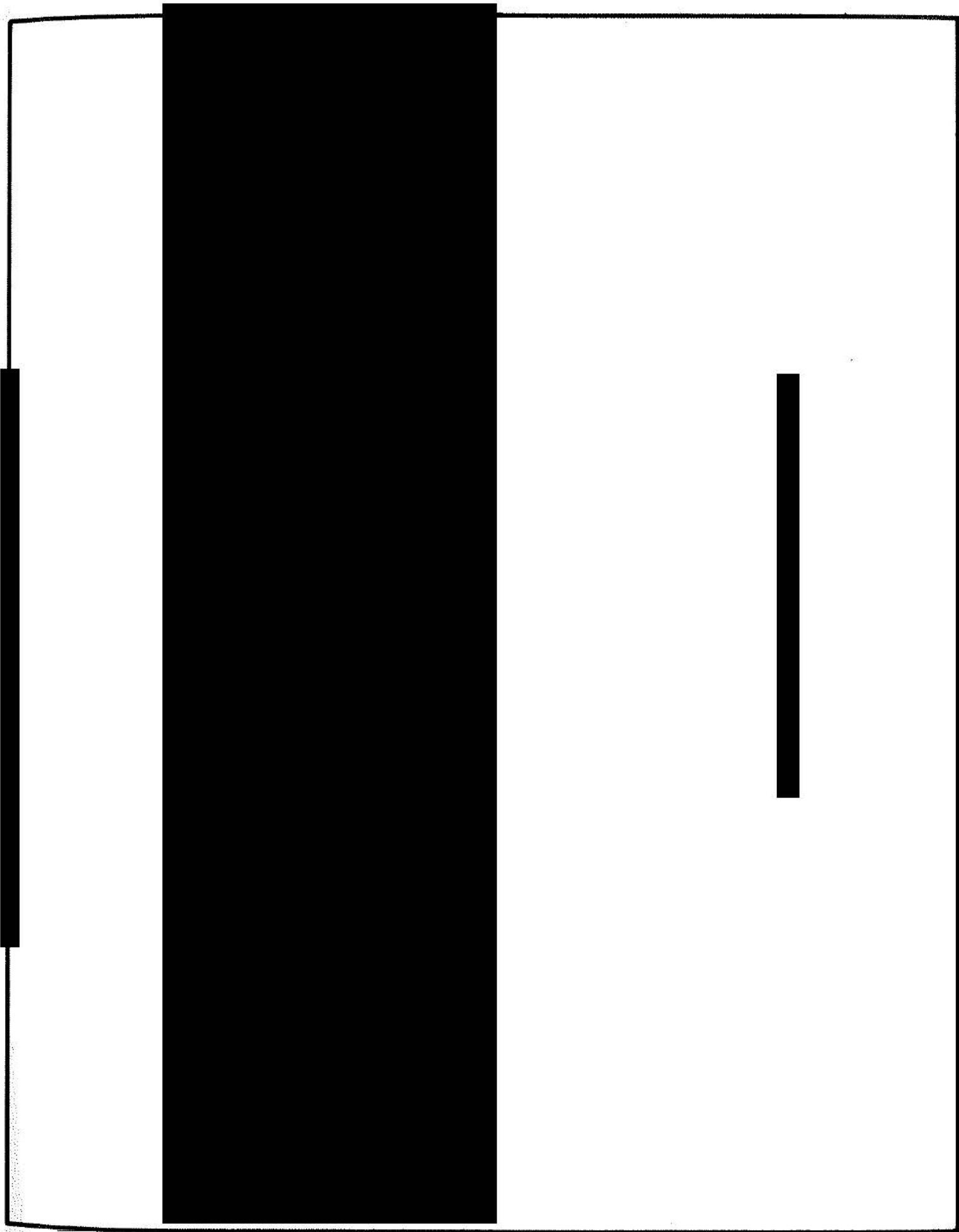

T. 15 N. on S.,  
R. 20 E., S. 20 on E., and  
S. 19 on W. faces; dug a pit, 36 x 36 x 12 ins., 8 ft. S. of post;  
and raised a mound of earth, 4 ft. base, 2 ft. high, S. of cor.

5. *Post, with Bearing Trees.*

Set a \_\_\_\_\_ post, 3 ft. long, 4 ins. sq., 24 ins. in the ground,  
for meander cor. of (e. g.) fracl. secs. 25 and 26,<sup>25</sup> marked

M. C. on N.,  
T. 15 N. on S.,  
R. 20 E., S. 25 on E., and  
S. 26 on W. faces; from which  
A \_\_\_\_\_, \_\_\_\_\_ ins. diam., bears S. \_\_\_\_\_° E., \_\_\_\_\_  
lks. dist., marked

T. 15 N., R. 20 E., S. 25, M. C. B. T.

A \_\_\_\_\_, \_\_\_\_\_ ins. diam., bears S. \_\_\_\_\_° W.,  
\_\_\_\_\_ lks. dist., marked

T. 15 N., R. 20 E., S. 26, M. C. B. T.

6. *Mound with Deposit, and Stake in Pit.*

Deposited a marked stone (charred stake or quart of charcoal) 12 ins. in the ground, for meander cor. of (e. g.) fracl. secs. 25 and 26;<sup>25</sup> dug a pit, 36 x 36 x 12 ins., 5 ft. N. of cor.; and raised a mound of earth, 4 ft. base, 2 ft. high, over deposit.

In the pit drove a \_\_\_\_\_ stake, 2 ft. long, 2 ins. sq., 12 ins. in the ground, marked

M. C. on S.,  
T. 15 N. on N.,  
R. 20 E., S. 26 on W., and  
S. 25 on E. faces.

7. *Tree Corner, with Pits and Mound of Earth.*

A \_\_\_\_\_, \_\_\_\_\_ ins. diam., for meander cor. of (e. g.) fracl. secs. 17 and 20,<sup>25</sup> I marked

M. C. on W.,  
T. 15 N. on E.,  
R. 20 E., S. 17 on N., and  
S. 20 on S. sides dug a pit, 36 x 36 x 12 ins., 8 ft. E. of tree;  
and raised a mound of earth, 4 ft. base, 2 ft. high, E. of cor.

8. *Tree Corner, with Bearing Trees.*

A \_\_\_\_\_, \_\_\_\_\_ ins. diam., for a special meander cor. of (e. g.) fracl. E. and W. halves of sec. 33,<sup>26</sup> I marked

S. M. C. on N.,  
T. 15 N. on S.,  
R. 20 E., S. 33 on E., and  
S. 33 on W. sides; from which  
A \_\_\_\_\_, \_\_\_\_\_ ins. diam., bears S. \_\_\_\_\_° E., \_\_\_\_\_  
lks. dist., marked

T. 15 N., R. 20 E., S. 33, S. M. C. B. T.

A \_\_\_\_\_, \_\_\_\_\_ ins. diam., bears S. \_\_\_\_\_° W.,  
\_\_\_\_\_ lks. dist., marked

T. 15 N., R. 20 E., S. 33, S. M. C. B. T.

9. *Pits and Mounds of Meander Corners.*

When a pit is dug as an accessory to a meander corner, it

will be located 8 feet from such corner (except as otherwise provided for in paragraph 6), on the side opposite the stream or lake meandered;

while the mound will be placed midway between the corner and nearest side of the pit.

10. *Markings on Meander Corners.*

On all meander corners, the letters "M. C." (for meander corner) will be cut into the side facing the stream or lake to be meandered. On post or tree meander corners, *within township exteriors*, additional marks will be placed, as follows: the *township* number will be marked on the side opposite "M. C."; the proper *range* and *section* number will be placed on the *right-hand side* (when looking along line toward the stream or lake), and the appropriate *section* number on the opposite side.

All meander corners on base lines or standard parallels will be marked S. C. on the *north* side or face.

On principal or guide meridians, and on *meridional* township lines, the letters "M. C." will be placed as above directed; the *township* number will be marked on the opposite side; while the proper *range* and *section* numbers will be marked on the sides facing the east and west cardinal points.

On base lines or standard parallels and on *latitudinal* township lines, the *township* numbers will be marked on the sides facing the north and south cardinal points; while the *range* and *section* numbers will be placed on the side opposite the marking "M. C."

In all the markings provided for in this paragraph, the *numbers* indicating townships, ranges, and sections, will be preceded by the initial letters "T." "R." and "S.", respectively.

11. *Descriptions will be modified in certain cases.*

When a tree is marked for a *regular* meander corner, the descriptions in paragraphs 8 will be modified, as follows: strike out "*special*"; in place of "E. and W. halves of sec. 33," write "secs. \_\_\_\_\_ and \_\_\_\_\_,"; and omit the letter "S.," preceding "M. C.," in the marking on corner and bearing trees.

The descriptions in paragraphs 1 to 7, inclusive, will be modified to describe *special* meander corners, as illustrated in paragraph 8, by writing "special" before meander cor. and "S." before "M. C.," when conditions require the change.

12. *Special Meander Corners and Auxiliary Meander Corners.*

Regular meander corners are those established on standard, township, or section lines. See Plate V, for plans of meander corners, and the specimen plat, Plate IV, sections 17, 18, 19, 20, 25, 26, and 35, for locations of the meander corners described in Specimen Field Notes, pages 208 to 210.

The meander corners, on lines of legal subdivisions, other

25. See Plate IV and page 188.

26. See Plate IV, and page 201. See paragraphs 11 and 12, page 44, and footnote, page 57.

than standard, township, or section lines, will be designated *special meander corners*, (e. g.) those located on the Specimen Plat, Plate IV, in section 33.

Meander corners, *not* on a line belonging to the system of rectangular surveying, will be called *auxiliary meander corners*, (e. g.) the meander corner on Diamond Rock, in section 18.

13. *Meander Corners on unsafe ground will be witnessed.*

When a Meander Corner falls at a point where prevailing conditions would insure its destruction by natural causes, a *witness corner* to such meander corner will be established, as provided for in the article "Witness Corners", page 47.

-45-

**CORNERS ON RESERVATION OR OTHER BOUNDARIES NOT CONFORMING TO THE SYSTEM OF RECTANGULAR SURVEYING.**

[See Plate VI.]

1. *Stone, with Mound of Earth.*

Set a \_\_\_\_\_ stone, \_\_\_\_\_ x \_\_\_\_\_ x \_\_\_\_\_ ins.,<sup>27</sup> \_\_\_\_\_ ins. in the ground, for the (e. g.) 17 mile cor., marked 17 M. on S., N. P. on E., and P. L. on W. faces; dug pits, 36 x 36 x 12 ins., E. and W. of stone, 4 ft. dist.; and raised a mound of earth, 5 ft. base, 2½ ft. high, S. of cor.

2. *Stone, with Mound of Stone.*

Set a \_\_\_\_\_ stone, \_\_\_\_\_ x \_\_\_\_\_ x \_\_\_\_\_ ins.,<sup>27</sup> \_\_\_\_\_ ins. in the ground, for the (e. g.) 38 mile cor., marked 38 M. on N. E., N. P. on N. W., and P. L. on S. E. faces; and raised a mound of stone, 3 ft. base, 2 ft. high,<sup>28</sup> N. E. of cor. Pits impracticable.

3. *Stone, with Bearing Trees.*

Set a \_\_\_\_\_ stone, \_\_\_\_\_ x \_\_\_\_\_ x \_\_\_\_\_ ins.,<sup>27</sup> \_\_\_\_\_ ins. in the ground, for the (e. g.) 35 mile cor., marked 35 M. on E., N. P. on N., and 8 W on S. faces; from which  
A \_\_\_\_\_, \_\_\_\_\_ ins. diam., bears N. \_\_\_\_\_° E., \_\_\_\_\_ lks. dist., marked  
N. P. I. R., 35 M. B. T.  
A \_\_\_\_\_, \_\_\_\_\_ ins. diam., bears S. \_\_\_\_\_° E.,<sup>29</sup> \_\_\_\_\_ lks. dist., marked  
T. 6 N., R. 8 W., S. 9, 35 M. B. T.  
A \_\_\_\_\_, \_\_\_\_\_ ins. diam., bears S. \_\_\_\_\_° W.,<sup>29</sup> \_\_\_\_\_ lks. dist., marked  
T. 6 N., R. 8 W., S. 8, 35 M. B. T.  
A \_\_\_\_\_, \_\_\_\_\_ ins. diam., bears N. \_\_\_\_\_° W., \_\_\_\_\_ lks. dist., marked  
N. P. I. R., 35 M. B. T.

4. *Post, with Pits and Mound of Earth.*

Set a \_\_\_\_\_ post, 3 ft. long, 5 ins. sq.,<sup>30</sup> with marked stone (charred stake or quart of charcoal), 24 ins. in the ground, for the (e. g.) 17 mile cor., marked

17 M. on S.,  
N. P. I. R. on E., and

P. L. on W. faces; dug pits, 36 x 36 x 12 ins., E. and W. of post, 4 ft. dist.; and raised a mound of earth, 5 ft. base, 2½ ft. high, S. of cor.

-46-

5. *Post, with Bearing Trees.*

Set a \_\_\_\_\_ post, 3 ft. long, 5 ins. sq.,<sup>30</sup> 24 ins. in the ground, for the (e. g.) 35 mile cor., marked

35 M. on E.,  
N. P. I. R. on N., and

T. 6 N., R. 8 W., S. 9, on S.; from which

A \_\_\_\_\_, \_\_\_\_\_ ins. diam., bears N. \_\_\_\_\_° E., \_\_\_\_\_ lks. dist., marked

N. P. I. R., 35 M. B. T.

A \_\_\_\_\_, \_\_\_\_\_ ins. diam., bears S. \_\_\_\_\_° E.,<sup>29</sup> \_\_\_\_\_ lks. dist., marked

T. 6 N., R. 8 W., S. 9, 35 M. B. T.

A \_\_\_\_\_, \_\_\_\_\_ ins. diam., bears S. \_\_\_\_\_° W.,<sup>29</sup> \_\_\_\_\_ lks. dist., marked

T. 6 N., R. 8 W., S. 8, 35 M. B. T.

A \_\_\_\_\_, \_\_\_\_\_ ins. diam., bears N. \_\_\_\_\_° W., \_\_\_\_\_ lks. dist., marked

N. P. I. R., 35 M. B. T.

6. *Mound, with Deposit and Stake in Pit.*

Deposited a marked stone (charred stake or quart of charcoal), 12 ins. in the ground, for the (e. g.) 33 mile cor.; dug pits, 36 x 36 x 12 ins., N. E. and S. W. of cor., 5 ft. dist.; and raised a mound of earth, 5 ft. base, 2½ ft. high, over deposit.

In N. E. pit drove a \_\_\_\_\_ stake, 2 ft. long, 2 ins. sq., 12 ins. in the ground, marked

33 M. on S. E.,

N. P. I. R. on N. E., and

T. 6 N., R. 8 W., S. 15 on S. W. faces.

7. *Tree Corner, with Pits and Mound of Earth.*

A \_\_\_\_\_, \_\_\_\_\_ ins. diam., for the (e. g.) 29 mile cor., I mark

29 M. on E.,

N. P. I. R. on N., and

T. 5 N., R. 7 W., S. 8 on S. sides; dug pits, 36 x 36 x 12 ins., N.

27. Stones for corners on Indian Reservation or other boundaries will not be less than 20 ins. long, or less than 6 ins. thick, and will measure at least one cubic foot in volume; consequently, a stone 20 x 14½ x 6 ins., will be about minimum size, and 3 x 9 x 6 ins., represents satisfactory proportions. "N. P." for "Nez Perces" (Indian Reservation), on the east, and "P. L." for "Public Land" (unsurveyed), on the west, applies to paragraph 1 only.

28. The above are minimum dimensions for mounds of stone on reservation boundaries.

29. The bearing trees, "S. \_\_\_\_\_° E." and "S. \_\_\_\_\_° W." from the corner, are supposed to stand on surveyed land, near the line between sections 8 and 9.

30. The stated dimensions of posts are minimum; if posts are longer than 3 feet, the extra length will be placed in the ground; the posts will in no case project more than 12 ins. above the natural surface of the earth.

and S. of tree, 5 ft. dist.; and raised a mound of earth, 5 ft. base, 2½ ft. high, E. of cor.

#### 8. *Tree Corner, with Bearing Trees.*<sup>29</sup>

A \_\_\_\_\_, \_\_\_\_\_ ins. diam., for the (e. g.) 35 mile cor., I mark

35 M. on E.,

N. P. I. R. on N., and

T. 6 N., R. 8 W., S. 9 on S. sides; from which

A \_\_\_\_\_, \_\_\_\_\_ ins. diam., bears N. \_\_\_\_\_° E., \_\_\_\_\_ lks. dist., marked

N. P. I. R., 35 M., B. T.

A \_\_\_\_\_, \_\_\_\_\_ ins. diam., bears S. \_\_\_\_\_° E., \_\_\_\_\_ lks. dist., marked

T. 6 N., R. 8 W., S. 9, 35 M., B. T.

A \_\_\_\_\_, \_\_\_\_\_ ins. diam., bears S. \_\_\_\_\_° W., \_\_\_\_\_ lks. dist., marked

T. 6 N., R. 8 W., S. 8, 35 M., B. T.

A \_\_\_\_\_, \_\_\_\_\_ ins. diam., bears N. \_\_\_\_\_° W., \_\_\_\_\_ lks. dist., marked

N. P. I. R., 35 M., B. T.

#### 9. *Corner Monument of Stone, with Deposit.*

Deposited a marked stone (charred stake, quart of charcoal, or vial with record<sup>31</sup> inclosed), 12 ins. in the ground, for the S. W. cor. of

-47-

(e. g.) the Nez Perces Indian Reservation; and built a monument of stone, 3 ft. sq. at base, 2 ft. sq. on top, 3 ft. high, over deposit; marked

S. W. cor., N. P. I. R. on N. E.,<sup>32</sup>

P. L., \_\_\_\_\_<sup>33</sup> M. \_\_\_\_\_<sup>33</sup> chs. on S. E.,

P. L., \_\_\_\_\_<sup>34</sup> on S. W., and

P. L. on N. W. faces.

#### 10. *A Post for Corner Monument, with Pits and Mound of Earth.*

Set a \_\_\_\_\_ post, 3 ft. long, 5 ins. sq., 24 ins. in the ground, for the N. W. cor. of (e. g.) the Nez Perces Indian Reservation, marked

P. L. on S. E.,

N. W. cor. N. P. I. R. on S. E.,

P. L. \_\_\_\_\_<sup>33</sup> M. \_\_\_\_\_<sup>33</sup> chs. on S. W., and

P. L. \_\_\_\_\_<sup>34</sup> on N. W. faces; dug pits, 36 x 36 x 12 ins., S. and N. E. of post, 8 ft. dist.; and raised a mound of earth, 5 ft. base, 2½ ft. high, S. E. of cor.

#### 11. *A Stone for Corner Monument, with Pits and Mound of Earth.*

Set a \_\_\_\_\_ stone, 36 x 10 x 7 ins., 27 ins. in the ground, for the N. E. cor. of (e. g.) the Nez Perces Indian Reservation; marked

P. L. on N. E.,

P. L. on S. E.,

N. E. cor., N. P. I. R. on S. W., and

P. L. on N. W. faces; dug pits 36 x 36 x 12 ins., S. and W. of

stone, 8 ft. dist.; and raised a mound of earth, 5 ft. base, 2½ ft. high, S. W. of cor.

#### 12. *Modifications of descriptions.*

When a stone or post is established for a corner monument (i. e.) at a *corner of a reservation*, and four (4) bearing trees are available, the descriptions in paragraph 10 and 11 will be modified, as follows: Replace all that refers to pits and mound of earth, by correct descriptions of four properly marked bearing trees, for each corner. (See paragraphs 3 and 5, pages 47, 48.)

The dimensions and arrangement of pits and mounds, described in the last two paragraphs, are similar to those described for "Corners referring to one township only." (See paragraphs 1 and 4, page 31.)

#### WITNESS CORNERS.<sup>35</sup>

##### 1. *Witness Corners will be established in certain cases.*

When the true point for any corner described in these instructions falls where prevailing conditions would insure its destruction by natural causes, a witness corner will be established in a secure position, *on a surveyed line if possible*, and *within twenty chains* of the corner point thus witnessed.

##### 2. *Markings on Witness Corners.*

A witness corner will bear the same marks that would be placed upon the corner for which it is a witness, and in addition, will have the letters "W. C." (for witness corner), *conspicuously* displayed above the

-48-

regular markings; such witness corners will be established, *in all other respects*, like a regular corner.

##### 3. *Markings on Bearing Trees of Witness Corners.*

When bearing trees are described as accessories to a witness corner, the prescribed markings on each tree will be preceded by the letters "W. C.," *distinctly* cut into the wood.

The true bearing and distance of witness corners, from the true point for the corner, will always be clearly stated in the field notes.

##### 4. *Witness Corners to corner points falling in roads, etc.*

The point for a corner falling on a railroad, street, or wagon road, will be perpetuated by a marked stone (charred stake or quart of charcoal), deposited 24 inches in the ground,<sup>36</sup> and

29. The bearing trees, "S. \_\_\_\_\_° E." and "S. \_\_\_\_\_° W." from the corner, are supposed to stand on surveyed land, near the line between sections 8 and 9.

31. The "record" will consist of a brief description of the corner, with the date of its construction.

32. The markings will be cut into large stones, inserted in the middle of the lowest course on each side of the monument.

33. The proper number of miles and chains, from the initial point, will be stated.

34. The year in which the monument is established will be placed in the blank.

35. See page 56.

36. The deposit will not be practicable in the case of railroads; but the witness corners will be established on the lines limiting the right of way. See pages 198, 209, and Plate IV.

witnessed by two witness corners, one of which will be established on each limiting line of the highway.

In case the point for any regular corner falls at the *intersection* of two or more streets or roads, it will be perpetuated by a marked stone (charred stake or quart of charcoal), deposited 24 inches in the ground, and *witnessed by two witness corners* established on opposite sides of the corner point, and at the mutual intersections of the lines limiting the roads or streets, as the case may be.

### WITNESS POINTS.

Witness points will be perpetuated by corners similar to those described for quarter section corners, with the marking "W. P." (for witness point), in place of "¼," or "¼ s.," as the case may be.

If bearing trees are available as accessories to *witness points*, each tree will be marked W. P. B. T. (See "Insuperable objects on line—Witness Points," page 22.)

### MISCELLANEOUS.

#### 1. *Corners on Rock in place, or on Boulders.*<sup>37</sup>

When a corner falls on rock *in place*, or on a *boulder*, a cross (x), will be made at the exact corner point, and witnessed by the proper number of bearing trees, if they are available; in the absence of suitable trees, a mound of earth will be raised, if size of the boulder or form of the rock in place permits the excavation of pits. As a last resort, a mound of stone will be built to attract attention to the point, if loose rock can be obtained in the vicinity

#### 2. *Location of Mounds.*

When mounds of earth or other material are raised as accessories to corners, they will be placed as specified in the foregoing Description of Corners, and in every case the *direction* of the mound from the corner will be carefully stated. The use of the indefinite description "alongside" will be discontinued.

In case the character of the land is such that the mound can not be placed as hereinbefore described, the deputy will state in his notes, by bearing and distance, exactly where the mound is located with reference to the corner, and will give his reasons for placing it as described.

#### 3. *Mounds of Stone, covered with Earth.*

In a case where pits are practicable and the deputy prefers raising a mound of stone, or a mound of stone covered with earth,<sup>38</sup> he will use the form given for "*Stone with mound of stone*," when the corner thus described is established; but when the corner "*Stone with mound of stone covered with earth*," is constructed, the description will be modified as follows: Strike out the words "Pits impracticable"; in place of "mound of stone, 2 ft. base, 1½ ft. high," write "mound of stone covered with earth, \_\_\_\_\_ ft. base, \_\_\_\_\_ ft. high," inserting in the blank spaces the dimensions of the mound given in paragraph 1, following the designation of each class of corners, pages 24 to 45.

#### 4. *Bearing Trees.*

Bearing trees marked as accessories to standard corners, either township, section, or quarter section, will be selected on the *north* side of base lines or standard parallels, and bearing trees referring to the closing corners on said lines, will be located on the *south* side; in general, the bearing trees referring to any particular closing corner, together with one pit and the mound belonging to such corner, will be located on *the same side of the line closed upon*, and on the side *from which the surveys have been closed*.

When the requisite number of trees can be found within 300 links of the corner point, two (2) bearing trees will be marked and described for every standard or closing township or section corner, or corner common to two townships or sections, only; four (4) for every corner common to four townships or four sections; one (1) for a corner referring to one township or one section, only; two (2) for every quarter section corner or meander corner, and four (4) for each mile or half mile corner, or corner monument on a reservation or other boundary, not conforming to the system of rectangular surveying.

In case the prescribed number of trees can not be found within limits, the deputy will state in his field notes, after describing those marked, "no other trees within limits," and add "dug pits \_\_\_\_\_ x \_\_\_\_\_ x \_\_\_\_\_ ins.," etc., or "raised a mound of stone, \_\_\_\_\_ ft. base, \_\_\_\_\_ ft. high, \_\_\_\_\_ of cor.," as prevailing conditions may require.

Bearing trees, being the most important accessories to the corners, will have their exact bearings from the true meridian taken with the instrument used in running lines of survey; and the distance *from the middle of each bearing tree to the middle point of the corner* will be carefully measured, and recorded in the field notes.

A *plain blaze* will be made at the usual or most convenient height, on each bearing tree, on the side facing the corner. The height of all other markings on the tree will in no case exceed the limit of *two and one-half* feet above the ground.

#### 5. *Stones for corners.*

Stones 18 ins. long, or less, will be set with two-thirds of their length in the ground, and those more than 18 ins. long will have three-fourths of their length in the ground.

No stones measuring less than 504 cubic inches, or less than 12 ins. in length, will be used for corners.

#### 6. *Objects to be noted.*

Particular attention is directed to the "Summary of objects and data required to be noted." See page 58 of these instructions; and the deputy will thoroughly comply with the same in his work and field notes.

37. See pages 146, 157, and 164.

38. The base and height of a "mound of stone, covered with earth," will be the same as prescribed for mound of earth. The dimensions of "mound of stone" on reservation boundaries will conform to those prescribed in paragraph 2, page 45. The direction of the mound from the corner will be stated.



### 7. *Lines discontinued at Legal Corners.*

No mountainous lands, or lands not classed as surveyable, will be meandered, and all lines approaching such lands will be discontinued at the section or quarter-section corner nearest the unsurveyed land.

### 8. *Marks to be cut.*

All letters and figures on posts, trees, or stones, etc., will be *cut into* the object upon which they are placed. Arabic figures and plain letters will be used for all markings.

### 9. *Orientation of Corners.*

Corners referring to one, two, or four townships or sections, not identical with standard or closing corners, will be set with their faces *directed* NE. and SW., and NW. and SE., while all other corners will be set with their sides *facing the cardinal points*; except corners on boundaries of reservations and private land claims, which will be set squarely on line.

### 10. *Size of Posts, Mounds, etc.*

The sizes of wooden posts, mounds, and pits, noted in the foregoing descriptions, will be regarded as *minimum*, and their dimensions will be increased whenever practicable.

### 11. *Corner Materials.*

In establishing corners, *durable* stones will be used when obtainable; then, posts; and lastly, mounds, with stake in pit.

Wood of a perishable nature will not be used for posts or stakes.

### 12. *Instructions will be examined.*

Deputy surveyors will carefully read, study, and familiarize themselves with all instructions contained in this volume, and will instruct their assistants as to their duties before commencing work. An extra copy of this Manual may be furnished each deputy, for the use of his assistants.

## INITIAL POINTS.

Initial points from which the lines of the public surveys are to be extended will be established whenever necessary, under such special instructions as may be prescribed in each case by the Commissioner of the General Land Office. The locus of such initial points will be selected with great care and due consideration for their prominence and easy identification, and must be established astronomically.

The lines of the public surveys are classified as follows:

Class 1. Base lines and standard parallels.

Class 2. Principal and guide meridians.

Class 3. Township exteriors (or meridional and latitudinal township boundaries).

Class 4. Subdivision and meander lines.

-51-

The initial point having been established, the line of the public surveys will be extended therefrom, as follows:

## BASE LINE.

1. From the initial point the base line will be extended east and west on a parallel of latitude, by the use of transit or solar instruments, as may be directed by the surveyor general in his written special instructions. The *transit* should be designated for the alinement of all important lines.

2. The direction of base lines will conform to parallels of latitude and will be controlled by true meridians; consequently the correct determination of true meridians by *observations on Polaris at elongation*<sup>39</sup> is a matter of prime importance.

3. When transits are employed, certain reference lines<sup>40</sup> having a known position and relation to the required parallel of latitude will be prolonged as straight lines, by two back and two fore sights at each setting of the instrument, the horizontal limb being revolved 180° in azimuth between the observations.

4. Where solar apparatus is used, the deputy will test the instrument, whenever practicable, by comparing its indications with a meridian determined by Polaris observations;<sup>41</sup> and in all cases where error is discovered he will make the necessary corrections of his line before proceeding with the survey.<sup>41</sup> All operations will be fully described in the field notes.

5. The proper township, section, and quarter section corners will be established at lawful intervals, and meander corners at the intersection of the line with all meanderable streams, lakes, or bayous.

6. In order to detect errors and insure accuracy in measurement, two sets of chainmen will be employed; one to note distances to intermediate points and to locate topographical features, the other to act as a check. Each will measure 40 chains, and the proper corner will be placed midway between the ending points of the two measurements.

The deputy will be present when said corner is thus established, and will record in the body of his field notes the distances to the same, according to the measurement by each set of chainmen.<sup>42</sup>

To obviate collusion between the sets of chainmen, the second set should commence at a point in advance of the beginning corner of the first set, the initial difference in measurement thus obtained being known only to the deputy.

## PRINCIPAL MERIDIAN.

1. This line shall *conform to a true meridian* and will be extended from the initial point, either north or south, or in both directions, as the conditions may require, by the use of transit or solar instruments, as may be directed by the surveyor general in his special written instructions.

2. The methods used for determination of directions, and the precautions to be observed to secure accuracy in measurement, are fully stated above under the title "Base Line", and will be complied with in every particular.

39. See page 105.

40. For details see pages 120 to 127.

41. See specimen field notes, page 172. of the range line, if the same is west of north, but subtract when it bears east of north.

42. See pages 142 to 167.

3. In addition to the above general instructions, it is required that

-52-

in all cases where the establishment of a new principal meridian seems to be necessary to the surveyor general, he shall submit the matter, together with his reasons therefor, to the Commissioner of the General Land Office, and the survey of such principal meridian shall not be commenced until written authority, together with such special instructions as he may deem necessary, shall have been received from the Commissioner.

### STANDARD PARALLELS.

1. Standard parallels, which are also called correction lines, shall be extended east and west from the principal meridian, at intervals of every 24 miles north and south of the base line, in the manner prescribed for running said line, and all requirements under the title "Base Line" will be carefully observed. (See page 51.)

2. Where standard parallels have been placed at intervals of 30 or 36 miles, regardless of existing instructions, and where gross irregularities require additional standard lines, from which to initiate new, or upon which to close old surveys, an intermediate correction line should be established to which a *local* name may be given, (e. g.) "Cedar Creek Correction Line;" and the same will be run, in all respects, like the regular standard parallels.

### GUIDE MERIDIANS.

1. Guide meridians shall be extended north from the base line, or standard parallels, at intervals of every 24 miles east and west from the principal meridian, in the manner prescribed for running the principal meridian, and all the provisions for securing accuracy of alinement and measurement found, or referred to under the title "Principal Meridian," will apply to the survey of said guide meridians. (See page 51.)

2. When existing conditions require that such guide meridians shall be run *south* from the base or correction lines, they will be initiated at properly established closing corners on such lines.

3. Where guide meridians have been improperly placed at intervals greatly exceeding the authorized distance of 24 miles, and standard lines are required to limit errors of old, or govern new surveys, a new guide meridian may be run from a standard, or properly established closing corner, and a local name may be assigned to the same, (e. g.) "Grass Valley Guide Meridian". These additional guide meridians will be surveyed in all respects like the regular guide meridians.

### TOWNSHIP EXTERIORS.

1. Whenever practicable, the township exteriors in a tract of land 24 miles square, bounded by standard lines, will be surveyed successively through the block, beginning with those of the *southwestern* township.

2. The *meridional* boundaries of townships will have precedence in the *order* of survey and will be run from south to

north on *true meridians*, with permanent corners at lawful distances; the latitudinal boundaries will be run *from east to west on random* or trial lines, and corrected back on true lines.

The falling of a *random*, north or south of the township corner to be closed upon, will be carefully measured, and, with the resulting true return course, will be duly recorded in the field notes.

-53-

Should it happen, however, that such *random* intersects the meridian of the objective corner, north or south of said corner, or falls short of, or overruns the length of the south boundary of the township by more than *three chains* (due allowance being made for convergency), said *random*, and, if necessary, all the exterior boundaries of the township, will be retraced and remeasured to discover and correct the error.

When running random lines from east to west, temporary corners will be set at intervals of 40.00 chains, and proper *permanent* corners will be established upon the true line, corrected back in accordance with these instructions, thereby throwing the excess or deficiency against the west boundary of the township, as required by law.

3. Whenever practicable, the exterior boundaries of townships belonging to the *west* range, in a tract or block 24 miles square, will first be surveyed in succession, through the range, from south to north; and in a similar manner, the other three ranges will be surveyed in regular sequence.

4. In cases *where impassable objects occur* and the foregoing rules *can not be complied with*, township corners will be established as follows:

In extending the *south* or *north* boundaries of a township to the *west*, where the *southwest* or *northwest* corners can not be established in the regular way by running a north and south line, such boundaries will be run *west on a true* line, allowing for convergency on the west half mile; and from the township corner established at the end of such boundary, the west boundary will be run *north* or *south*, as the case may be. In extending *south* or *north* boundaries of a township to the *east*, where the *southeast* or *northeast* corner can not be established in the regular way, the same rule will be observed, except that such boundaries will be run *east on a true* line, and the *east* boundary run *north* or *south*, as the case may be.

5. Allowance for the convergency of meridians will be made whenever necessary.

### METHOD OF SUBDIVIDING.

1. The exterior boundaries of a full township having been properly established, the subdivision thereof will be made as follows:

At or near the *southeast* corner of the township, a *true meridian* will be determined by Polaris or solar observations, and the deputy's instrument will be tested thereon; then from said corner the first mile of the east and south boundaries will be retraced, if subdivisions and survey of the exteriors have been provided for in *separate* contracts; but, if the survey of the exterior and subdivisional lines are included in the *same* contract, the retracements referred to will be omitted. All discrepancies resulting from disagreement of bearings or measurements will be carefully stated in the field notes.

2. After testing his instrument on the true meridian thus determined, the deputy will commence at the corner to sections 35 and 36, on the south boundary, and run a line *parallel to the range line*,<sup>43</sup> establishing at 40.00 chains, the quarter section corner between sections 35 and 36, and at 80.00 chains the corner for sections 25, 26, 35, and 36.

3. From the last-named corner, a random line will be run eastward, without blazing, parallel to the *south boundary of section 36*, to its inter-

-54-

section with the east boundary of the township, placing at 40.00 chains from the point of beginning, a post for temporary quarter section corner. If the random line intersects said township boundary exactly at the corner for sections 25 and 36, it will be blazed back and established as the true line, the permanent quarter section corner being established thereon, *midway* between the initial and terminal section corners.

If, however, the random intersects said township boundary to the north or south of said corner, the falling<sup>44</sup> will be carefully measured, and from the data thus obtained, the true return course will be calculated,<sup>45</sup> and the true line blazed and established and the position of the quarter section corner determined, as directed above.

The details of the entire operation will be recorded in the field notes.

4. Having thus established the line between sections 25 and 36; from the corner for sections 25, 26, 35, and 36, the *west* and *north* boundaries of sections 25, 24, 13, and 12, will be established as directed for those of section 36; with the exception that the random lines of said north boundaries will be run *parallel to the established south boundaries of the sections to which they belong*, instead of the south boundary of section 36; e. g. the random line between sections 24 and 25 will be run parallel to the established south boundary of section 25, etc.

5. Then, from the last established section corner, i. e. the corner for sections 1, 2, 11, and 12, the line between sections 1 and 2, will be projected northward, on a random line, *parallel* to the *east* boundary of the township, setting a post for temporary quarter section corner at 40.00 chains, to its intersection with the north boundary of the township. If the random intersects said north boundary exactly at corner for sections 1 and 2, it will be blazed back and established as the true line, the temporary quarter section corner being established permanently in its original position, and the fractional measurement thrown

-55-

into that portion of the line between said corner and the north boundary of the township.

If however, said random intersects the north boundary of the township, to the east or west of the corner for sections 1 and 2, the consequent falling will be carefully measured, and from the data thus obtained the true return course will be calculated<sup>46</sup> and the true line established, the permanent quarter section corner being placed upon the same at 40.00 chains from the initial corner of the random line, thereby throwing the fractional measurement in that portion lying

TABLE A.—Corrections for Convergency, within a Township.

Latitude.	Correction to be applied to bearing of range lines at a distance of—				
	1 mile.	2 miles.	3 miles.	4 miles.	5 miles.
° °	'	'	'	'	'
30 to 35 . . . . .	1	1	2	2	3
35 to 40 . . . . .	1	1	2	3	3
40 to 45 . . . . .	1	2	2	3	4
45 to 50 . . . . .	1	2	3	4	5

Example.—Latitude, 47. Range line bears N. 0° 2' E.; then parallel meridional section lines will be run as follows:

- From the corner for sections—
- 35 and 36, N. 0° 1' E.
- 34 and 35, north.
- 33 and 34, N. 0° 1' W.
- 32 and 33, N. 0° 2' W.
- 31 and 32, N. 0° 3' W.

between the quarter section corner and the north boundary of the township.

When the north boundary of a township is a base line or standard parallel, the line between sections 1 and 2 will be run *parallel to the range line as a true line*, the quarter section corner will be placed at 40.00 chains, and a *closing corner* will be established at the point of intersection with such base or standard line; and in such case, the distance from said closing corner, to the nearest standard corner on such base or standard line, will be carefully measured and noted as a *connection line*.

6. Each successive range of sections progressing, to the west, until the fifth range is attained, will be surveyed in a similar manner; then, from the section corners established on the west boundary of said range of sections, random lines will be projected to their intersection with the west boundary of the township, and the true return lines established as prescribed for the survey of the first or most eastern range of sections, with the exception that on the true lines thus established the quarter section corners will be established at 40.00 chains from the the initial corners of the randoms, the frac-

43. The meridional section lines will be made parallel to the range line or east boundary of the township, by applying to the bearing of the latter a small correction, dependent on the latitude, taken from the following table, which gives, to the nearest whole minute, the convergency of two meridians 6 miles long and from 1 to 5 miles apart; and supplies directly the deviation of meridional section lines west of north, when the range line is a true meridian. Add the correction to the bearing of the range line, if the same is west of north, but subtract when it bears east of north.

44. See "Prescribed Limits," page 59.

45. See Table VII, and rules, page 128. Random bearings, determined as directed above, are actually the true bearings of fractional true lines and are so used for running them. Any deviation from random bearings, derived from the application of the falling [Table VII], changes the random bearing by an amount due to unavoidable errors, and should give for a final result a bearing as near the true bearing as the field work will permit. A true bearing means the angular deviation from the true meridian in contradistinction to the magnetic bearing, or angle made with the magnetic meridian. A true line will be understood to refer to the line upon which the corners are established.

46. See Table VII and rules, page 128.

tional measurements being thereby thrown into those portions of the lines situated between said quarter section corners and the west boundary of the township.

7. The following general requirements are reiterated for emphasis:

The *random* of a latitudinal section line will always be run parallel to the south boundary of the section to which it belongs, and with the true bearing of said boundary; and when a section has no linear south boundary, the random will be run parallel to the south boundary of the range of sections in which it is situated, and fractional true lines will be run in a similar manner.<sup>47</sup>

8. The deputy is not required to complete the survey of the first range of sections from south to north before commencing the survey of the second or any subsequent range of sections, but the corner on which any random line closes shall have been previously established by running the line which determines its position, except as follows: Where it is impracticable to establish such section corner in the regular manner, it will be established by running the latitudinal section line as a *true line*, with a *true bearing*, determined as above directed for *random* lines, setting the quarter section corner at 40.00 chains and the section corner at 80.00 chains.<sup>48</sup>

9. Quarter section corners, both upon meridional and latitudinal section lines, will be established at points *equidistant* from the corresponding section corners, *except* upon the lines closing on the north and west boundaries of the township, and in those situations the quarter section corners will always be established at precisely *forty chains* to the north or west (as the case may be) of the respective section corners from which those lines respectively *start*, by which procedure the

-56-

excess or deficiency in the measurements will be thrown, according to law, on the extreme tier or range of quarter sections, as the case may be.

10. Where by reason of impassable objects only a portion of the south boundary of a township can be established, an auxiliary base line (or lines,<sup>49</sup> as the case may require) will be run through the portion which has no linear south boundary, first random, then corrected, connecting properly established corresponding section corners (either interior or exterior) and as far south as possible, and from such line or lines, the section lines will be extended northwardly in the usual manner, and any *fraction south* of said line will be surveyed in the opposite direction from the section corners on the auxiliary base thus established. (See Plate I, figs. 3, 4, and 5.)

11. Where by reason of impassable objects *no portion of the south boundary* of a township can be regularly established, the subdivision thereof will proceed from *north to south* and from east to west, thereby throwing all fractional measurements and areas against the west boundary, and the meanderable stream or other boundary limiting the township on the south.

If the *east* boundary is without regular section corners and the north boundary has been run eastwardly as a true line, with section corners at regular intervals of 80.00 chains, the subdivision of the township will be made from *west to east*, and fractional measurements and areas will be thrown against the irregular east boundary.

12. When the proper point for the establishment of a township or section corner is inaccessible, and a witness corner can be erected upon each of the two lines which approach the same, at distances not exceeding twenty chains therefrom, said witness corners<sup>5</sup> will be properly established, and the half miles upon which they stand will be recognized as *surveyed lines*.

The witness corner will be marked as conspicuously as a section corner, and bearing trees will be used wherever possible.

The deputy will be required to furnish good evidence that the section corner is actually inaccessible.

## MEANDERING.

1. Proceeding *down* stream, the bank on the *left* hand is termed the *left bank* and that on the *right* hand the *right bank*. These terms will be universally used to distinguish the two banks of a river or stream.

2. Navigable rivers, as well as all rivers not embraced in the class denominated "navigable," the right-angle width of which is three chains and upwards, will be meandered on both banks, at the ordinary *mean high water mark*, by taking the general courses and distances of their sinuosities, and the same will be entered in the field book. Rivers not classed as navigable will not be meandered above the point where the average right-angle width is less than three chains. Shallow streams, without any well-defined channel or permanent banks, *will not be meandered*; except tide-water streams, whether more or less than three chains wide, which should be meandered at ordinary high-water mark, as far as tide-water extends.

At every point where either standard, township, or section lines intersect the bank of a navigable stream, or any meanderable line, corners will be established at the time of running these lines. Such corners

-57-

are called meander corners,<sup>50</sup> and the deputy will commence at one of these corners, follow the bank or boundary line, and measure the length of each course from the beginning corner to the next "meander corner." Compass courses, by the needle or solar, will be used in meanders. Transit angles are not allowed.

The crossing distance between meander corners on same line and the true bearing and distance between corresponding meander corners will be ascertained by triangulation, or direct measurement, in order that the river may be projected with entire accuracy. The particulars will be given in the field notes.

5. See "Witness Corners," page 47.

47. See Plate IV, between sections 7 and 18, and 17 and 20.

48. See Plate IV, between sections 8 and 17.

49. Section corners will be established by correct alinement and measurement of meridional sectional lines whenever practicable.

50. These corners are the regular meander corners, and designated "meander corners;" they are distinguished from special and auxiliary meander corners; see paragraphs 11 and 12, page 44, and pages 42 and 43.

In meandering water courses or lakes, where a distance is more than ten chains between successive stations, whole chains only should be taken; but if the distance is less than *ten chains*, and it is found convenient to employ chains and links, the number of links should be a *multiple of ten*, thereby saving time and labor in testing the closings, both in the field and office.

3. The meanders of all lakes, navigable bayous, and deep ponds, of the area of twenty-five acres and upwards, will be commenced at a meander corner and continued, as above directed for navigable streams; from said corner, the courses and distances of the entire margin of the same, and the intersections with all meander corners established thereon, will be note.

All streams falling into the river, lake, or bayou will be noted, and the width at their mouths stated; also, the position, size, and depth of springs, whether the water be pure or mineral; also, the heads and mouths of all bayous; all islands, rapids, and bars will be noted, with intersections, to their upper and lower ends, to establish their exact situation. The elevation of the banks of lakes, bayous, and streams, the height of falls and cascades, and the length and fall of rapids will be recorded in the field notes.

To meander a lake or deep pond lying entirely within the boundaries of a section, two lines will be run from the two nearest corners on different sides of such lake or pond, the courses and length of which will be recorded, and if coincident with unsurveyed lines of legal subdivisions, that fact will also be stated in the field notes, and at each of the points where said lines intersect the margin of the pond or lake, a *special*<sup>51</sup> meander corner will be established as above directed. (See example, page 201.)

The relative position of these points being thus definitely fixed in the section, the meandering will commence at one of them and be continued to the other, noting the intersection, and thence to the beginning. The proceedings are to be fully entered in the field notes.

4. Meander lines will not be established at the segregation line between dry and swamp or overflowed land, but at the *ordinary high-water mark* of the actual margin of the rivers or lakes on which such swamp or overflowed lands border.

5. The precise relative position of an island, in a township made fractional by a river or lake in which the island is situated, will be determined by triangulation from a special and carefully measured base line, initiated upon the surveyed lines, on or near the lake or river bank on the main land, so as to connect by course and distance on a direct

-58-

line, the meander corner on the mainland with the corresponding point on the island, where the proper meander corner will be established.

6. In making the connection of an island lying entirely within a section, with the mainland, a special base will be measured from the most convenient meander corner, and from such base, the location of an *auxiliary*<sup>52</sup> meander corner will be determined by triangulation, at which the meanders of the island will be initiated.

7. In the survey of lands bordering on *tide water*, "meander corners" will be established at the points where surveyed

lines intersect *high-water mark*, and the meanders will follow the *high-water line*.

8. The field notes of meanders will show the dates on which the work was performed, as illustrated in the specimen notes, page 216. The field notes of meanders will state and describe the corner from which the meanders commenced, and upon which they closed, and will exhibit the meanders of each fractional section separately; following, and composing a part of such notes, will be given a description of the land, timber, depth of inundation to which the bottom is subject, and the banks, current, and bottom of the stream or body of water meandered. The utmost care will be taken to pass no object of topography, or *change therein*, without giving a particular description thereof in its proper place in the notes of the meanders.

#### SUMMARY OF OBJECTS AND DATA REQUIRED TO BE NOTED.

1. The precise length of every line run, noting all necessary offsets therefrom, with the reason for making them, and method employed.

2. The kind and diameter of all bearing trees, with the course and distance of the same from their respective corners; and the precise relative position of witness corners to the true corners.

3. The kind of materials of which corners are constructed.

4. *Trees on line*. The name, diameter, and distance on line to all trees which it intersects.

5. Intersections by line of *land objects*. The distance at which the line intersects the *boundary lines* of every reservation, settler's claim, improvement, or rancho; prairie, bottom land, swamp, marsh, grove, and windfall, with the course of the same at all points of intersection; also, the distances at which the line begins to ascend, arrives at the top, begins to descend, and reaches the foot of all *remarkable hills and ridges*, with their courses, and *estimated height in feet*, above the level land of the surrounding country, or above the bottom lands, ravines, or waters near which they are situated. Also, distance to and across *large ravines*, their depth and course.

6. Intersections by line of *water objects*. All rivers, creeks, and smaller streams of water which the line crosses; the distances measured on the *true line* to the bank *first arrived at*, the course *down stream* at *points of intersection*, and their *widths on line*. In cases of *navigable streams*, their width will be ascertained between the *meander corners*, as set forth under the proper head.<sup>53</sup>

7. The land's *surface*—whether level, rolling, broken, hilly, or mountainous.

8. The *soil*—whether first, second, third, or fourth rate.

9. *Timber*—the several kinds of timber and undergrowth, in the order in which they predominate.

51. A "Special Meander Corner" is one established on a line of legal subdivision, not a standard, township, or section line. See pages 201 and 202.

52. An "auxiliary meander corner" is one not on a line belonging to the system of rectangular surveying. See page 212.

53. See "Meandering," third clause of paragraph 2, page 57.

10. *Bottom lands*—to be described as wet or dry, and if subject to inundation, state to what depth.

11. *Springs of water*—whether fresh, saline, or mineral, with the course of the streams flowing from them.

12. *Lakes and ponds*—describing their banks and giving their height, and also depth of water, and whether it be pure or stagnant.

13. *Improvements*. Towns and villages; houses or cabins, fields, or other improvements with owners' names; mill sites, forges, and factories, mineral monuments, and all corners not belonging to the system of rectangular surveying; will be located by bearing and distance, or by intersecting bearings from given points.

14. *Coal banks or beds; peat or turf grounds; minerals and ores*; with particular description of the same as to quality and extent, and all *diggings* therefor; also *salt springs and licks*. All reliable information that can be obtained respecting these objects, whether they be on the line or not, will appear in the general description.

15. *Roads and trails*, with their directions, whence and whither.

16. Rapids, cataracts, cascades, or falls of water, with the estimated height of their fall in feet.

17. Precipices, caves, sink holes, ravines, stone quarries, ledges of rocks, with the kind of stone they afford.

18. *Natural curiosities*, interesting fossils, petrifications, organic remains, etc.; also all ancient works of art, such as mounds, fortifications, embankments, ditches, or objects of like nature.

19. The *magnetic declination* will be *incidentally* noted at all points of the lines being surveyed, where any *material change* in the same indicates the probable presence of iron ores; and the position of such points will be perfectly identified in the field notes.

**PRESCRIBED LIMITS FOR CLOSINGS AND LENGTHS OF LINES.**

1. If in running a *random* township exterior, such random falls short of or exceeds its proper length by more than *three chains*, or falls more than *three chains* north or south of its objective corner, it will be re-run, and if found correct, so much of the remaining boundaries of the township will be retraced or resurveyed,<sup>54</sup> as may be found *necessary* to locate the error.

2. Every meridional section line, except those terminating in the north boundary of the township, shall be *eighty chains* in length.<sup>55</sup>

3. The *random* meridional section lines through the north tier of sections shall fall within *fifty links* east or west of the section corners established on the north boundary of the township, *except* when closing on a base line or standard parallel.

4. The actual length of meridional section lines through the north tier of sections shall be within *one hundred and fifty links* of their theoretical length. The latter will be determined from the meridional boundaries of the north tier of sections.

5. All *random* latitudinal section lines shall fall within

*fifty links* north or south of their objective section corners.

In any range of sections, the difference between the true bearing of a latitudinal section line and that of the south boundary of the range, shall not exceed 21 minutes of arc.

The *latitudinal* section lines, except those terminating in the west boundary of the township, shall be within *fifty links* of the actual distance established on the south boundary line of the township for the width of the range of sections to which they belong.

6. The north boundary and the south boundary of *any one section*,

except in the extreme western range of sections, shall be within *fifty links* of equal length.

7. The meanders within each fractional section, or between any two successive meander corners, or of an island in the interior of a section, should close within a limit to be determined by allowing *five-eighths of a link for each chain* of said meander line. Where the meander corners marking the ends of a meander line in a fractional section are located on standard, township, or section lines, the above limit, increased by *one fourth of the regular perimeter of the fractional section, expressed in miles, multiplied by 71 links, will be allowed.*<sup>56</sup>

The extreme limit, however, will in no case be permitted to exceed *one hundred and fifty links*.

**FIELD NOTES.**

1. The proper blank books for *original field notes* will be furnished by the surveyor general, and in such books the deputy surveyor will make a faithful, distinct, and minute record of everything done and observed by himself and his assistants, pursuant to instructions, in relation to running, measuring, and marking lines, establishing corners, etc., and present, as far as possible, full and complete topographical sketches of all standard and exterior lines, drawn to the usual scale for township exteriors. These "original field notes" are not necessarily the entries made in the field, in the deputy's pocket notebooks called tablets; but they are to be fully and correctly written out in ink, from such tablets, for the permanent record of the work. Tablets should be so fully written as to verify the "original field notes" whenever the surveyor general requires them for inspection.

2. A full description of all corners belonging to old surveys, from which the lines of *new* surveys *start*, or upon which they *close*, will in all cases be furnished the deputy from the surveyor general's office, when authority is given for commencing work; then, if the old corners are found to agree with said descriptions, the deputy will describe any one of them in this form, "which is a stone firmly set, marked, and witnessed, as described by the surveyor general"; but, should a corner *not* answer the description supplied, the deputy will give a *full description* of such corner and its accessories, following the proper approved form given in these instructions.

54. See "Explanations," p. 71 to 78.

55. See exception on p. 76.

56. See Plate I, figs. 8, 9, 10, 11, and 12.

A full description of each corner established under any one contract will be given *once* only; subsequent reference to such corner will be made in the form, "heretofore described", or (e. g.) "the corner for sections 2, 3, 10, and 11," as the case may require.

In all cases where a corner is *reestablished*, the *original field notes* will describe fully the manner in which it is done.

3. The *original field notes* of the survey of base, standard, and meridian lines will describe all corners established thereon, how established, the crossings of streams, ravines, hills, and mountains; character of soil, timber, minerals, etc.; and after the description of each township corner established in running such lines, the deputy will note particularly in the "general description" the character of townships on each side of the lines run.

4. The *original field notes* of the survey of exterior boundaries of townships will describe the corners and topography, as above required, and the "general description" at the end of such notes will describe the townships as fully as possible, and also state whether or not they should be subdivided.

-61-

5. The *original field notes* of the subdivisional survey of townships will describe the corners and topography as above required, and the "general description" at the end of such notes will state minutely the character of the land, soil, timber, etc., found in such townships.

The topography will be given on the *true line* in all cases, and will be taken correctly, not estimated or approximated.

6. With the *original field notes* of the survey of base lines and standard parallels, and principal and guide meridians forming a tract 24 miles square,<sup>57</sup> including those of the township exteriors therein, the deputy will submit a diagram of the lines surveyed, drawn to a scale of half an inch to one mile, upon which will be written the *true bearings and lengths of all surveyed lines*, except the lengths of those which are actually 40.00 or 80.00 chains. These diagrams will exhibit all water courses, with the direction of each indicated by an arrow head pointing *down stream*; also, the intersection of the lines with all prairies, marshes, swamps, ravines, lakes, ponds, mountains, hills, and all other natural or artificial topographical features mentioned in the *original field notes*, to the fullest extent possible.

7. With the *special instructions* for making subdivisional surveys of townships into sections, the deputy will be furnished by the surveyor general with *blank township diagrams* drawn to a scale of *one inch to forty chains*, upon which the *true bearings and lengths of the township and section lines, from which the surveys are to be projected, or upon which they are to close, will be carefully marked*; and on such diagrams the deputy who subdivides will make appropriate sketches of the various objects of topography as they occur on his lines, so as to exhibit not only the points of intersection therewith, but also the directions and relative positions of such objects between the lines, or within each section, as far as practicable, so that every topographical feature may be properly completed and connected in the showing.

8. Triangulations, offsets, or traverses, made to determine distances that can not be directly measured, such as those over (e. g.) deep streams, lakes, impassable swamps, canons,

etc., will be made on the *random lines*,<sup>58</sup> when random lines are run. All particulars will be fully stated in the field notes.

The exhibition of every mile of surveying, whether on standard, township, or subdivision lines, and the meanders in each section, will be complete in itself, and will be separated from other records by a black line drawn across that part of the page containing the body of notes. The description of the surface, soil, minerals, timber, undergrowth, etc., on *each mile* of line will follow the notes of survey of such line, and *not be mingled with them*.

Particular care will be taken to record at the end of each mile the number of chains of *mountainous land, heavily timbered land, or land covered with dense undergrowth*. (See page 224.)

The date of each day's work will immediately follow the notes thereof.

9. Near the end of the *original field notes* and immediately before the "general description", the deputy surveyor will add, in the form shown in specimen field notes (page 177), a tabular statement of the latitude and departure of all boundary lines of the township, derived from a traverse table, and will give the *totals*, and the *errors* in latitude and departure; said errors shall in no case exceed *three chains*, the prescribed limit for the falling of the *random* north boundary of a township. If a part or the whole of one or more boundaries is made up of meander lines, the northings, southings, eastings, and westings of the

-62

full section lines, nearest said meanders, will replace the missing N., S., E., or W. township lines, as the case may require, thereby presenting the *errors* of said boundaries of a closed survey.

If all the exterior lines have been surveyed by the deputy, the bearings and distances for the table will be taken from his own notes. In a case where some of the boundaries have been surveyed under another contract, the deputy will use the bearings and distances supplied by the surveyor general, in connection with those of his own lines; and, if errors exceed the allowance of *three chains*, specified in paragraph 1 of the "Prescribed Limits",<sup>59</sup> the deputy will determine *where the error occurs, correct the same before he leaves the field, and place the table in his original field notes*.

Besides the ordinary notes taken on line (and which will always be written down on the spot, leaving nothing to be supplied by memory), the deputy will subjoin, at the conclusion of his book, such further description or information touching any matter or thing connected with the township (or other) survey which he may be able to afford, and may deem useful or necessary to be known—with a *general description* of the township in the *aggregate*, as respects the face of the country, its soil and geological features, timber, minerals, waters, etc.

10. Following the general description of the township will be placed "A list of the names of the individuals employed to assist in running, measuring, and marking the lines and

57. See page 52 and Plate III.

58. See pages 136 and 188.

59. See page 59, and retracement article, page 72.

corners described in the foregoing field notes of township No. \_\_\_\_\_ of the base line of range No. \_\_\_\_\_ of the \_\_\_\_\_ meridian, showing the respective capacities in which they acted."

**AFFIDAVITS TO FIELD NOTES.**

The following are the forms of official oaths to be taken by deputy surveyors and their assistants. The original oaths will be affixed to the *original field notes* forwarded to the surveyor general by the deputy surveyor; the preliminary oaths being placed on the page following the index of the first book, and the final oaths at the end of the last book of field notes of the survey of *each class of lines*<sup>60</sup> to which they refer:

**PRELIMINARY OATHS OF ASSISTANTS.**

We, \_\_\_\_\_ and \_\_\_\_\_, do solemnly swear that we will well and faithfully execute the duties of chainmen; that we will level the chain upon even and uneven ground and plumb the tally pins, either by sticking or dropping the same; that we will report the true distance to all notable objects, and the true length of all lines that we assist in measuring, to the best of our skill and ability, and in accordance with instructions given us, in the survey of the \_\_\_\_\_.

\_\_\_\_\_, *Chainman.*  
\_\_\_\_\_, *Chainman.*

Subscribed and sworn to before me this \_\_\_\_\_ day of \_\_\_\_\_, 189\_\_\_\_.  
[SEAL.] \_\_\_\_\_,

We, \_\_\_\_\_ and \_\_\_\_\_, do solemnly swear that we will well and truly perform the duties of moundmen in the establishment of corners, according to the instructions given us, to the best of our skill and ability, in the survey of \_\_\_\_\_.

\_\_\_\_\_, *Moundman.*  
\_\_\_\_\_, *Moundman.*

Subscribed and sworn to before me this \_\_\_\_\_ day of \_\_\_\_\_, 189\_\_\_\_.  
[SEAL.] \_\_\_\_\_,

-63-

We, \_\_\_\_\_ and \_\_\_\_\_, do solemnly swear that we will well and truly perform the duties of axmen, in the establishment of corners and other duties, according to instructions given us, to the best of our skill and ability, in the survey of \_\_\_\_\_.

\_\_\_\_\_, *Axman.*  
\_\_\_\_\_, *Axman.*

Subscribed and sworn to before me this \_\_\_\_\_ day of \_\_\_\_\_, 189\_\_\_\_.

[SEAL.] \_\_\_\_\_,

I, \_\_\_\_\_, do solemnly swear that I will well and truly perform the duties of flagman, according to instructions given me, to the best of my skill and ability, in the survey of \_\_\_\_\_.

\_\_\_\_\_, *Flagman.*

Subscribed and sworn to before me this \_\_\_\_\_ day of \_\_\_\_\_, 189\_\_\_\_.

[SEAL.] \_\_\_\_\_,

**FINAL OATHS OF DEPUTY SURVEYORS AND THEIR ASSISTANTS.**

*List of names.*

A list of the names of the individuals employed by \_\_\_\_\_, United States deputy surveyor, to assist in running, measuring, and marking the lines and corners described in the foregoing field notes of the survey of \_\_\_\_\_, showing the respective capacities in which they acted.

- \_\_\_\_\_, *Chainman.*
- \_\_\_\_\_, *Chainman.*
- \_\_\_\_\_, *Chainman.*
- \_\_\_\_\_, *Chainman.*
- \_\_\_\_\_, *Moundman.*
- \_\_\_\_\_, *Moundman.*
- \_\_\_\_\_, *Axman.*
- \_\_\_\_\_, *Axman.*
- \_\_\_\_\_, *Flagman.*

**FINAL OATHS OF ASSISTANTS.**

We hereby certify that we assisted \_\_\_\_\_, United States deputy surveyor, in surveying all those parts or portions of the \_\_\_\_\_ of the \_\_\_\_\_ base and \_\_\_\_\_ meridian, \_\_\_\_\_ of \_\_\_\_\_, which are represented in the foregoing field notes as having been surveyed by him and under his direction; and that said survey has been in all respects, to the best of our knowledge and belief, well and faithfully surveyed, and the corner monuments established according to the instructions furnished by the United States surveyor general for \_\_\_\_\_.

- \_\_\_\_\_, *Chainman.*
- \_\_\_\_\_, *Chainman.*
- \_\_\_\_\_, *Chainman.*
- \_\_\_\_\_, *Chainman.*
- \_\_\_\_\_, *Moundman.*
- \_\_\_\_\_, *Moundman.*
- \_\_\_\_\_, *Axman.*
- \_\_\_\_\_, *Axman.*
- \_\_\_\_\_, *Flagman.*

60. See page 50, and par. 13 (a) page 64.



Subscribed and sworn to before me this \_\_\_\_\_ day of \_\_\_\_\_, 189\_\_\_\_.

[SEAL.] \_\_\_\_\_, \_\_\_\_\_.

**FINAL OATH OF UNITED STATES DEPUTY SURVEYOR.**

I, \_\_\_\_\_, United States deputy surveyor, do solemnly swear that in pursuance of instructions received from \_\_\_\_\_, United States surveyor general for \_\_\_\_\_, bearing date of the \_\_\_\_\_ day of \_\_\_\_\_, 189\_\_\_\_, I have well, faithfully, and truly, in my own proper person, and in strict conformity with the instruction furnished by the United States surveyor general for \_\_\_\_\_, the Manual of Surveying Instructions, and the laws of the United States, surveyed all those parts or portions of \_\_\_\_\_

-64-

\_\_\_\_\_ of the \_\_\_\_\_ base and \_\_\_\_\_ meridian in the \_\_\_\_\_ of \_\_\_\_\_, which are represented in the foregoing field notes as having been surveyed by me and under my directions; and I do further solemnly swear that all the corners of said survey have been established and perpetuated in strict accordance with the Manual of Surveying Instructions, and the special written instructions of the United States surveyor general for \_\_\_\_\_, and in the specific manner described in the field notes, and that the foregoing are the true field notes of such survey; and should any fraud be detected, I will suffer the penalty of perjury, under the provisions of an act of Congress approved August 8, 1846.

\_\_\_\_\_  
United States Deputy Surveyor.

Subscribed by said \_\_\_\_\_, U. S. deputy surveyor, and sworn to before me this \_\_\_\_\_ day of \_\_\_\_\_, 189\_\_\_\_.  
[SEAL.] \_\_\_\_\_, \_\_\_\_\_.

11. The final oath of the deputy surveyor will be taken before the U. S. Surveyor General for the State or Territory in which the survey is executed, or before any other officer authorized by the laws of the United States or by the municipal authorities, to administer land oaths, except notaries public.

It is preferable that both preliminary and final oaths of assistants should be taken before some officer duly authorized to administer oaths other than the deputy surveyor. In cases, however, where great delay, expense, or inconvenience would result from a strict compliance with this rule, the deputy surveyor is authorized to administer the necessary oaths to his assistants, but in each case where this is done, he will submit to the proper surveyor general, a full written report of the circumstances which required his stated action.

12. The deputy will transmit the original field notes and the required sketches to the surveyor general at the earliest practicable date after completion of his work in the field. Said original field notes will be filed in the office of the surveyor general as a part of its permanent records, subject only to the

direction of the Commissioner of the General Land Office; and no changes whatever will be made in said original field notes, after they have been filed in the surveyor general's office.

13. The original field notes, each bearing the written approval of the surveyor general, will be substantially bound in volumes of suitable size and retained in the surveyor general's office. Certified transcripts of said original field notes will be prepared at the earliest practicable date, as follows:

(a) The field notes of the survey of base lines and standard parallels, of principal and guide meridians, of township exteriors, and of subdivision and meander lines will be written in separate books. A complete set of preliminary and final oaths will be attached to the field notes of each class of lines.<sup>61</sup> No adhesive material of any kind will be used to fasten leaves or covers. Cut or mutilated leaves, or slips, will not be inserted.

(b) The field notes of subdivisions will be written in a separate book for each township; the preliminary oaths of the assistants employed in making said subdivisions will be prefixed to the first book, and their final oaths will be attached to the last book of the series, arranged in the order of dates.

(c) The first or title page of each book of field notes will describe the subject matter of the same, the locus of the survey, by whom surveyed, number and date of contract, and the dates of commencement and completion of the work.

-65-

(d) The second page of each book of field notes will contain the names and duties of the assistants employed on the surveys recorded therein; the index will be placed on the same or following page.

(e) Whenever a new assistant is employed, or the duties of any one of them changed, such fact will be stated in an appropriate entry immediately preceding the notes taken under such changed arrangements.

(f) No abbreviations or contractions of words are allowable, except such words as are constantly occurring, and a few others, additional to those enumerated on page 23, as follows:

astron.	for astronomical.	l. m. t.	for local mean time.
chs.	for chains.	long.	for longitude.
corr.	for correction.	m.	for minutes.
decl.	for declination.	mag. decl.	for magnetic declination.
diff. lat.	for difference of latitude.	red.	for reduce or reduction.
dep.	for departure.	temp.	for temporary.
h.	for hours.	U. C.	for upper culmination.
lat.	for latitude.	w. corr.	for watch correction.
L. C.	for lower culmination.	w. t.	for watch time.

Proper names will never be abbreviated, however often they recur.

(g) All transcripts of field notes, made out as herein directed, will be written on official field-note paper, foolscap size (pages 13½ x 8½ inches), in a bold, legible hand, or type-written, and as nearly as possible without erasures or interlineations; such transcripts of any series of surveys, included in one account forwarded to the General Land Office, will be securely put up in one package, at the office of the surveyor general, prior to transmission.

61. See classification of lines, page 50.

**SPECIAL INSTRUCTIONS ISSUED BY UNITED STATES SURVEYORS GENERAL TO UNITED STATES DEPUTY SURVEYORS.**

One of the most important duties to be performed by the surveyor general is to provide the deputy surveyor with *Special Instructions*, in connection with the contract, prepared in accordance with law, which instructions will not consist of directing attention to certain paragraphs in this Manual, reiteration of its requirements, and printed directions of a general nature; but they will in all cases be *specific* in character, with all necessary *detailed statements* setting forth *what* the deputy is to do and *how* the work is to be performed. Before making out special instructions, the surveyor general will cause a thorough examination to be made of the field notes and plats of older surveys of standard and township lines upon which the deputy is to base his work, and give him *full* information—both *written* and *graphic*—of the exact condition of adjoining surveys, with all *irregularities* that may be found, carefully and clearly noted; with all necessary instructions for his guidance if he finds everything *as it should be*, and, in addition, full advice as far as practicable what to do in case the surveys on the ground are *not as represented* in the old notes.

If the contract includes exterior lines, the surveyor general will specify in detail where the deputy is to commence, in what *order* and in what *direction* he is to run the lines, and provide for his use a *diagram*, drawn to a scale of one inch to one mile, giving full and accurate information in regard to lengths and bearings of all lines of old surveys, *from* which he is to work, or *upon* which he is to close. The diagrams will be made in triplicate, one copy for the General Land Office, one for the deputy, and one to be retained; they may be either original drawings, or blue prints or tracings therefrom. *In no case must the deputy be sent*

-66-

*into the field without full and accurate information in regards to all irregularities on the records which will affect the extent or accuracy of his survey.*

**SPECIMEN FIELD NOTES.**

[See Plates III and IV.]

Specimen field notes Nos. 1, 2, 3, 4, and 5, illustrate, respectively, the method and order to be followed in the survey of standard parallels, guide meridians, and township exteriors; *resurvey* of township exteriors; and the subdivision of a township into sections and quarter sections.

The attention of every deputy surveyor is particularly directed to these specimens, as indicating not only the method by which his work will be conducted, but also the form, order, language, etc., in which his field notes will be prepared for the office of the surveyor general, and such specimens will be deemed a part of these instructions; and any *departure from their details*, in cases where the circumstances are analogous in practice, *will be regarded as a violation of his contract and oath.*

**DIAGRAM OF TOWNSHIP EXTERIORS.**

[See Plate III.]

The title, certificate, and remarks on Plate III, with the specimen field notes Nos. 1, 2, and 3, will fully explain the drawing designated "Township Exteriors."

In all cases the *true bearing and length* of each township boundary will be clearly stated on the diagram; and, when any township boundary entered on the diagram, surveyed under the current contract, or a prior contract, departs from the true meridian, or proper latitude curve (as the case may be), or falls short of or overruns its proper length, by an amount in excess of the prescribed limits of *three chains* (page 59, paragraph 1), *the actual position and extent* of said township boundary will be *graphically* exhibited on the diagram, as well as by bearing and length recorded in the field notes.

**SPECIMEN TOWNSHIP PLAT.**

[See Plate IV.]

Plate IV illustrates the subdivision of a town ship into sections and quarter sections; the record of said subdivision being given in detail in specimen field notes No. 5.

The subdivision of fractional sections into forty-acre lots (as near as may be) will be so laid down on the official township plat in broken black lines as to admit of giving to each a *specific designation by word description*, if possible, according to its relative position in the fractional section, as per examples on Plate IV; or by a number, in all cases where the lot can not properly be designated as a quarter quarter. Those fractional lots which are not susceptible of being described according to relative local position will be numbered in a regular series; those bordering on the north boundary of a township to be numbered progressively from east to west, and those bordering on the west boundary of a township to be numbered progressively from north to south, in each regular section. As section 6 borders on both the north and west boundaries of the township, the fractional lots in the

-67-

same will be numbered as follows: commencing with No. 1 in the northeast, thence progressively west to No. 4 in the northwest, and south to No. 7 in the southwest corner of the section.

To secure a uniform system for numbering lots of fractional sections, including those above specified, imagine the section divided by three equidistant parallel latitudinal lines into four strips or tiers, 1 numbered from north to south; then, beginning with the *eastern lot* of the north tier, call it No. 1, and continue the numbering *west* through the tier, then *east* in the second, *west* in the third, and *east* in the fourth tier. A lot extending north and south through two, or part of two tiers, will be numbered in the tier containing its greater area. In case any tier is *without* numbered lots, the numbering will be continued in the next tier to the south. (Plate IV, section 18.)

This method of numbering will apply to any part of a section, regardless of the relative situation of a part or parts

surveyed and lotted under a prior contract; in this case the lot numbers will be a continuation of the series already initiated.

Interior lots will be, as nearly as possible, 20.00 chains long by 20.00 chains wide; and the excess or deficiency of measurement will always be thrown against the northern or western boundary of the section, or meander line, or irregular boundary, as the case may be.

When, by reason of irregular surveys or from other causes, the length of a township from south to north exceeds the lawful length of 480.00 chains, or the width from east to west exceeds 480.00 chains *minus* the proper convergency, to such extent as to require two or more tiers of lots along the north boundary, or two or more ranges of lots along the west boundary, as the case may be, the entire north or west halves of said sections will be properly lotted, and to each lot will be assigned its proper number; and in such cases the area of each lot will be stated on the plat.

In case the length or width of the township falls so far short of legal dimensions as to *eliminate* the north or west half of any section situated as above specified, that part of the section remaining will be treated in a similar manner.

In a regular township (Plate IV) the southeast quarter of the northwest quarter of section 6 will have its proper area in acres (40) inserted in all cases. The half quarter sections in north tier and west range of sections will exhibit their proper areas in acres (80); while the areas of *quarter sections* will be omitted, except as follows:

When two lines of legal subdivision of either 160, 80, or 40 acre tracts intersect each other on or so near a meander or boundary line that the ordinary inaccuracies of drawing would leave the areas of said tracts in doubt, the plats will, for the sake of clearness and a full showing of the facts, exhibit the proper areas of such quarter, half quarter, and quarter quarter sections. See examples, Plate IV, in sections 13, 17, 25, and 35.

Plats shall not be trimmed. A margin of *three inches for binding* will be preserved on the left-hand side of each plat. Each plat will be certified by the surveyor general, with table annexed, according to the form on Plate IV, and will exhibit the area of public land, water surface, townsite, private land claims, and mineral claims, with the total area of the township.

Each township plat will be prepared in *triplicate*: one for the General Land Office, one for the United States district land office, and the third will be retained as the record in the office of the surveyor general.

The plat for the local land office will not be forwarded until notice is

-68-

received by the surveyor general from the Commissioner of the General Land Office that the survey represented on said plat has been accepted, and that he is authorized to file the triplicate plat.

The plats will be prepared as nearly as possible in accordance with the specimen plat designated "Plate IV." The use of all fluids, except a preparation of India ink of good quality, must be avoided by the draughtsman in delineations relating to the public surveys. All lines, figures, etc., will be sharply

defined. All lettering on the plats must be clear and sharp in outline and design, and *black*; ornamentation of any kind is prohibited. These requirements are necessary in order that everything shown upon original plats may be fairly reproduced in making photolithographic copies of the same.

All towns, settlements, permanent buildings, private claims, reservations, water courses, ditches, lakes, islands, mountains, buttes, canons, roads, railroads, telegraph lines, canals, etc., will be shown upon the plats and designated by proper names where such are known.

All township plats are to be drawn to a uniform scale of 1 inch to 40 chains, United States standard, and diagrams of exteriors to a scale of 1 inch to 160 chains.

Surveyors general will require that the specimen plat shall be closely followed, in order that uniformity of appearance and expression of drawing representing the public land surveys may be attained.

With the copy of each township plat furnished to a district land office, the surveyor general is required by law to furnish *descriptive notes* of the character and quality of the soil and timber found on and in the vicinity of each surveyed line, and to give a description of each corner.

Printed blank forms of such notes are furnished by the General Land Office. The forms provide eighteen spaces for *meander corners*, which, in most cases, will be sufficient; but when the number shall exceed eighteen, the residue will have to be inserted on the supplemental blank form.

A series of meander corners are shown on Plate IV, viz: From No. 1 to No. 8, on Yellowstone River; No. 9 to No. 10, on Clear Lake; No. 11 to No. 15, on Lin's Lake; No. 16 to No. 17, on Ivy Island; and No. 18, on Diamond Rock.

### COMPUTATION OF THE AREAS OF LOTS ADJOINING THE NORTH AND WEST BOUNDARIES OF REGULAR TOWNSHIPS.

1. In regular townships, the tracts of land in each section adjoining the north and west boundaries of such townships, in excess of the regularly subdivided 480 acres (except in section 6), will, in general, be in the form of trapezoids, 80.00 chains in length by about 20 chains in width.

On the plats of such townships, each of said tracts will be divided into four lots, by drawing broken lines at intervals of 20.00 chains, parallel to the ends of the tracts, which will be regarded as parallel to each other.

With the exception of section 6, the south boundaries of sections of the north tier, when within prescribed limits, will be called 80.00 chains

When the above-named conditions obtain, the areas of the lots in any one tract (except in section 6) may be determined, as follows:

Divide the *difference* between the widths of the ends of the tract by 4; if 3 remains, increase the hundredth figure of the quotient by a unit; in *all other cases* disregard the fraction; call the quotient thus obtained,

-69-

"d"; then, taking the end widths of the tract in *chains and decimals of a chain*, the areas of the lots, in *acres*, will be:

Of the *smallest* lot: twice the width of the *lesser* end, plus "d";

Of the *largest* lot: twice the width of the *greater* end, minus "d";

Of the *smaller middle* lot: sum of the widths of the ends, minus "d";

Of the *larger middle* lot: sum of the widths of the ends, plus "d".

A check on the computation may be had by multiplying the sum of the widths, of the ends of the tract by 4; the product should agree *exactly* with the total area of the four lots.

The proper application of the above rules will always give areas correct to the nearest hundredth of an acre; and, as the use of fractions is entirely avoided, the method is recommended for its simplicity and accuracy.

Example 1. (See Plate IV, section 31.)

The 1/4 difference of latitudinal boundaries is 0.03 3/4 chains; consequently, "d" is .04 chains; then,

18.35 × 2	+ .04 =	36.74 acres, the area of lot 1;
18.50 × 2	- .04 =	36.96 acres, the area of lot 4;
18.50 + 18.35	- .04 =	36.81 acres, the area of lot 2;
18.50 + 18.35	+ .04 =	36.89 acres, the area of lot 3;

Check: [18.35 + 18.50] × 4 = 147.40 acres, the area of the four lots.

The arithmetical operations are here written in detail, for the purpose of illustration; but the practical computer will perform all the work mentally.

2. Section 6. (See Plate I, figs. 6 and 7; and Plate IV.) The areas of lots 5, 6, and 7 may be obtained by the foregoing rules in all cases, *except* when the township closes on a base line or standard parallel; also, the area of lot 4, *provided* both meridional boundaries are 80.00 chains in length; when the last condition obtains, the areas of lots 1, 2, and 3 will be equal, and each will contain 40.00 acres.

In any case where the west boundary of sec. 6, is 80.00 chains, and the *east* boundary either *greater or less than* 80.00 chains, the areas of lots 1, 2, 3, and 4 will be computed as follows:

Refer to figures 6 and 7 and determine the difference, "q", between the *east* boundaries of lots 1 and 4 by the following proportion:

N. bdy. sec. 6. : diff. of meridional bdrs. sec. 6. : 60 chs. : q; then will E. bdy. lot 4 = E. bdy. lot 1 ± q; in which "q" will be *added* when the *east* boundary of sec. 6 is *less than 80.00 chains* (fig. 7.); but *subtracted* when said east boundary is *greater than 80.00 chains* (fig. 6).

Now take *one third* of "q", and add it to the *shorter east boundary* of lots 1 or 4, as conditions may require, and thereby determine the length of one of the *meridional* boundaries of lot 2; to which, again add "one third of q", and thus obtain the length of the opposite side of lot 2. The areas of lots 1, 2, and 3, in acres, will be found by taking the sum of their respective *meridional boundaries, expressed in chains and decimals of a chain.*

The area of lot 4 may be had by multiplying its *mean width* by its *mean length.*

Finally, to test the entire work, multiply the sum of the *latitudinal* boundaries by 4, and to the product *add* the area of the small triangle C A B, if the east boundary is *greater* than 80.00 chains (fig. 6); but subtract the area of said small triangle if the east boundary is *less than* 80.00 chains (fig. 7). These operations, correctly performed,

will give the *true area of the section*, which should agree *exactly* with the total area of its legal subdivisions, obtained as directed in the preceding paragraphs.

Example 2. (See Plate I, figs. 6 and 7, and Plate IV.)

Compute areas of lots 5, 6, and 7 of sec. 6, as directed in paragraph 1, and illustrated by the example; then write:

chs.	chs.	chs.	chs.		chs.
77.75	: 0.05	:: 60.00	: 0.0386	= q; 1/3 q =	0.0129
chs.		chs.	chs.		
20.0500	-	0.0386	= 20.01, <sup>62</sup>	the E. bdy. of lot 4;	
20.0114	+	0.0129	= 20.02,	the E. bdy. of lot 3;	
20.0243	+	0.0129	= 20.04,	the E. bdy. of lot 2.	

Then, for the areas of lots 1, 2, 3, and 4, we have:

chs.	chs.		acres.	
20.05 + 20.04	..... =	40.09,	the area of lot 1;	
20.04 + 20.02	..... =	40.06,	the area of lot 2;	
20.02 + 20.01	..... =	40.03,	the area of lot 3;	
20.00 + 20.01	× $\frac{17.75 + 17.78}{2}$ =	35.54,	the area of lot 4.	

Also [17.78 + 17.87] × 3 = 106.95, the area of lots 5, 6, and 7.

Area of regular subdivisions = 360.00

Total..... = 622.67, The area of Sec. 6.

chs.	chs.		
[77.87 + 77.75]	× 4 =	622.48	
77.75	× 0.025 =	0.19,	the area of triangle C A B (fig. 6)

Total..... = 622.67, which agrees with the area of section 6, before determined.

3. The area in acres of a tract 40.00 chains long, adjoining north or west township boundaries (except in N. W. 1/4 sec. 6), is equal to the sum of its *parallel boundaries* (expressed in chains and decimals thereof) multiplied by 2; (e. g.) the area of lots 6 and 7 (Plate I, fig. 6), is [17.87 + 17.81] × 2 = 71.36 acres.

The area in acres of a tract 60.00 chains long, situated as above described (excluding lot 4, of sec. 6), may be found by multiplying the sum of its *parallel boundaries* (expressed in chains and decimals of a chain) by 3; (e. g.) fig. 6; south boundary lot 4 = 17.78 chs.; area of lots 5, 6, and 7 is [17.78 + 17.87] × 3 = 106.95 acres. (See example 2.)

The area in acres of quarter sections adjoining north and west township boundaries (excluding N. W. 1/4 sec. 6), may be obtained by multiplying the sum of their *parallel boundaries* (taken in chains and decimals of a chain), by 2; (e. g.) the area of S. W. 1/4 sec. 6 (fig. 6), is [37.87 + 37.81] × 2 = 151.36 acres.

The area in acres of any section along the north and west boundaries of regular townships (except sec. 6) may be had by multiplying the sum of its *parallel boundaries* (expressed in chains and decimals of a chain) by 4; (e. g.) the area of sec. 1 (Plate IV) is [80.00 + 79.77] × 4 = 639.08 acres.

The area in acres of a *theoretical* township may be obtained

62. These measures are taken to the nearest hundredth only.

by multiplying the sum of its *latitudinal* boundaries (expressed in chains and

-71-

decimals of a chain) by 24; (e. g.) the area of the township represented by Plate I, fig. 1 is  $[480.00 + 479.34] \times 24 = 23,024.16$  acres.

### EXPLANATIONS OF ARTICLES ON PAGES 72 to 78, WITH GENERAL DEFINITIONS OF A "RETRACEMENT" AND A "RESURVEY."

When new surveys are to be initiated from, or closed upon the lines of old surveys, which although reported to have been executed correctly, are found to be actually defective in alinement, measurement, or position, it is manifest that the employment of the regular methods prescribed for surveying normal township exteriors and subdivisions would result in extending the imperfections of the old surveys into the new, thereby producing irregular townships bounded by exterior lines not in conformity with true meridians or parallels of latitude, and containing trapezium-shaped sections which may or may not contain 640 acres each, as required by law.

Therefore, in order to extend such new surveys without incorporating therein the defects of prior erroneous work, special methods, in harmony as far as practicable with the following requirements, should be employed, viz:

The establishment of township boundaries conformable to true meridian and latitude lines.

The establishment of section boundaries by running two sets of parallel lines governed respectively by true meridians and parallels of latitude, and intersecting each other approximately at right angles at such intervals as to produce tracts of square form containing 640 acres each.

The reduction to a minimum of the number of fractional lots in a township, and consequently of the amount of field and office work.

Such special methods are based upon certain limits of allowable error in the alinement, measurement, and position of old township boundaries, as prescribed in the following article entitled "DEFINITIONS OF DEFECTIVE TOWNSHIP BOUNDARIES," page 72, which will be determined and rectifications made, if necessary, under the provisions of the article entitled "RETRACEMENT OR RESURVEY OF TOWNSHIP LINES AND LINEAR BOUNDARIES NOT ESTABLISHED IN CONFORMITY WITH THE RECTANGULAR SYSTEM OF SURVEYING," page 72, prior to the execution of new surveys under the methods prescribed by the article entitled "METHODS OF EXECUTING NEW SURVEYS, WHEN INITIATED FROM OR CLOSED UPON DEFECTIVE OLD SURVEYS," page 75, and illustrated on Plate VII, by figures 1 to 15; on Plate VIII, figures 1 to 7, and on Plate IX.

In order to prevent any misunderstanding relative to the *modus operandi* indicated by the terms "retracement" and "resurvey," the following definitions of the same are here presented:

The *retracement* of a township boundary, or other line of survey, consists in the determination of the true bearings and distances between the successive corners along the entire

length of such a line; and the data thus obtained will be embodied in the field notes together with detailed particulars of the methods employed.

The *resurvey* of a township boundary or other line of survey consists of a retracement of such a line accompanied by the reconstruction of defective original corners and the establishment thereon of all the necessary new corners, and the detailed particulars of the entire operation will be embodied in the field notes.

-72-

### DEFINITIONS OF DEFECTIVE TOWNSHIP BOUNDARIES.

1. Upon retracement thereof, an old township boundary may be found to be defective in one or all of three qualifications, viz: *alinement*, *measurement*, and position, as follows:

2. In *alinement*; when any portion thereof deviates more than twenty-one minutes of arc from a true meridian or latitude line.

3. In *measurement*; in the case of a meridional line, or a *latitudinal* line which is identical with a standard parallel; when its length is greater or less than six miles by more than three chains; or when the length of any portion thereof between two successive corners, is greater or less than forty chains; excepting that portion between the last established corner and the limiting line, which may be greater or less than forty chains, when such a boundary has been closed upon the bank of a meanderable body of water, a military or Indian reservation, or State boundary, etc., as the case may be.

4. In *measurement*; in the case of a *latitudinal* line not identical with a portion of a standard parallel; when its length is greater or less than *six miles minus the proper correction for convergency*, by more than three chains; or when the length of any portion thereof between two successive corners is greater or less than forty chains; except, when such a boundary has been run as a true line to an intersection with any line of limitation, that portion thereof, between the last established subdivisional corner and the limiting line, may be greater or less than forty chains; and also, when it has been established in the regular manner, i. e. by random and true lines, that portion thereof in which the fractional measurement was originally allowed for may be greater or less than forty chains.

5. In *position*; when the corners originally established on such a boundary can not be connected with the corners on the opposite regularly established boundary, by lines which *do not* deviate more than twenty-one minutes of arc from true meridian or latitude lines.

6. The limits prescribed in the foregoing paragraphs are to be considered only in determining the necessity of *resurveying* old township boundaries when new surveys are to be initiated from or closed upon the same, *and will not be construed in any way as establishing limits of allowable error in the execution of new surveys.*

**RETRACEMENT OR RESURVEY OF TOWNSHIP  
LINES AND LINEAR BOUNDARIES NOT  
ESTABLISHED IN CONFORMITY WITH THE  
RECTANGULAR SYSTEM OF SURVEYING.<sup>63</sup>**

If in subdividing a township, it is found that any boundary thereof is defective in excess of the limits of allowable error prescribed in the article entitled "Definitions of Defective Township Boundaries," above, or that the corners originally established thereon had been incorrectly marked, or have been obliterated, the deputy surveyor will resurvey so much of said boundaries as may be necessary, as follows:

1. When subdivisional lines have not been closed upon either side of, or mineral claims tied to, a township boundary, it will be corrected (if necessary), in point of alinement, as well as measurement, by establishing regular new corners at lawful distances (*minus the northing or plus the southing of the south boundary; or minus the westing or plus the easting of the east boundary*), from said boundaries respectively (as the case may be), upon a right line connecting the proper township corners,

-73-

*provided* said line *does not* deviate more than twenty-one minutes of arc from a true meridian or latitude line (as the case may be). (See Plate VII, figs. 1, 2, 3.)

But, if the bearing of said line exceeds the limit prescribed above, the new corners will be placed on a line run *due north or west*, from the southeast corner of the township, to intersection with the township or range line (as the case may be), where a closing corner will be established, and the old township corner properly changed to a corner common to two townships.

The old corners on all township boundaries rectified under the provisions of this paragraph will be destroyed. (See Plate VII, figs. 4 and 5.)

2. Where subdivisional lines *have* been closed upon one side of, or mineral claims tied to, a township boundary prior to the subdivision of the township on the other side, *its alinement will not be changed*; all obliterated old corners will be *reestablished* in their original places; new regular corners common to two townships, sections, or quarter sections, will be established upon it at lawful distances, *minus the northing or plus the southing of the south boundary; or minus the westing or plus the easting of the east boundary*, from said boundaries respectively (as the case may be), marked with reference to the township being subdivided, and the marks on the old corners upon such boundary which refer to the new work will be effaced.

Marks on bearing trees will be corrected (if necessary) to indicate the township, range, and section in which they stand, but the pits and mounds will remain as originally established. (See Plate VII, figs. 6 and 7.)

3. Where subdivisional lines *have* been closed upon one side of, or mineral claims tied to, the northern portion of a range line prior to the subdivision of the township on the other side (see paragraph 2), while upon the southern portion of the same such attachments have not been made on either

side (see paragraph 1), said southern portion will be resurveyed and proper new corners established thereon, at lawful distances from the south boundary, as follows:

If the bearing of said *southern* portion *does not* deviate more than twenty-one minutes of arc from a true meridian line, it will be rectified under the provisions of the first clause of paragraph 1, and the rectifications will be continued on the *northern* portion under the provisions of paragraph 2. (See Plate VII, fig. 8.)

If, however, said bearing exceeds the specified limit, from the northern terminal corner of said southern portion, the range line will be extended *due south on a random* to its intersection with the south boundary where a corner common to two townships will be established, all the necessary changes made in the markings on the original corner common to four townships situated in its immediate vicinity, and regular new corners placed upon the respective portions of the entire range line as specified in the foregoing clause. (See Plate VII, fig. 9.)

Similar cases involving the rectification of the northern portion of a range line when the southern portion of the same can not be rectified in bearing, will be treated in conformity with the rules prescribed in the foregoing clauses, with the exception, that where such northern portion deviates more than twenty-one minutes of arc from a true meridian line, its alinement will be rectified by extending the same from its southern terminal corner, *due north* on a true line to its intersection with the north boundary, where a proper closing corner will be

-74-

established and the necessary corrections applied to the old corner common to four townships in its immediate vicinity, so as to change it to a corner common to two townships. (See Plate VII, figs. 10, 11, and 12.)

In the treatment of *latitudinal* township lines the rule prescribed in the foregoing clauses will be applied, observing, however, that the stated designations *north* or *south* will correspond in such cases to *west* or *east*, respectively.

4. When subdivisional lines have been closed upon one or both sides of, or mineral claims tied to, the northern and southern portions of a range line, while the middle portion thereof is free from such attachments, said portion will be resurveyed and new regular corners will be established thereon at intervals of forty chains from its southern terminal corner, upon a right line connecting the original terminal corners thereof, the fractional measurement being thrown against the northern terminal corner. (See Plate VII, figs. 13, 14, and 15.)

In such cases all the original corners, excepting the terminal corners, of the portion of the lines thus resurveyed, will be destroyed.

The rectification of the middle portions of latitudinal township lines, on which the conditions specified above obtain, will be executed in a similar manner, observing, however, that the designations *north* or *south* in the foregoing clauses will in such cases correspond to *west* or *east*, respectively.

5. Under the foregoing paragraphs, the fact that mineral claims have been tied to a defective township boundary as

63. Regarding permission to resurvey, see page 224.

therein specified, will act as a bar to the rectification of such a boundary in alinement, only when the number of claims involved is great; while in cases where a few such claims have been connected with a few of the corners on such a boundary, said boundary will be rectified in alinement and new corners placed thereon, care being taken, however, to perpetuate in a proper manner such old corners as are found to be connected with the claims; and the methods employed to accomplish the same, together with the bearings and distances of such old corner from the new, will be briefly and accurately recorded in the field notes.

New corners on defective township boundaries must be established by an actual survey of such lines, and in no case will such corners be established from data acquired in running lines closing upon the same.

In the retracement or resurvey of base lines, standard parallels, principal meridians and guide meridians, two sets of chainmen will be employed, while for similar work on township lines, not of the character specified above, only one set of chainmen is required, and in cases where conditions such as specified in paragraph 2 obtain, the bearings and distances between successive old corners and the connections of all new corners with the nearest old corners will be carefully determined and recorded in the field notes.

When township or subdivisional lines intersect the boundaries of confirmed private land claims, or any other linear boundaries established at variance with the rectangular system of surveying, as much of said boundaries will be retraced as may be necessary, temporary stakes being set at intervals of *ten chains* thereon, and also at each angle formed by a change in the direction of the same.

All obliterated boundary corners will be reestablished in their original places, and the regular surveys will be closed upon the retraced line as prescribed for "closings" in the last clause of par. 5, page 55.

---

NOTE.—Regarding restoration of lost corners, by private and county surveyors, see page 224.

-75-

### METHODS OF EXECUTING NEW SURVEYS, WHEN INITIATED FROM OR CLOSED UPON OLD SURVEYS, AND EXPLANATION OF FIGURES ON PLATE VII.

Such methods are illustrated by the several figures on Plate VII, the rectification of the lines of old surveys, and the establishment of *new* township exterior and subdivisional lines connected with such old lines, being based upon the rules prescribed in the article entitled "Retracement or Resurvey of Township Lines," &c., page 72.

In considering the several cases, the probable obtaining conditions relative to a *range line* have been adopted in order to reduce the number of figures on said plate, and, to curtail also as much as practicable, the amount of reiterative verbal explanations; it being definitely understood, however, that whatever conditions may obtain relative to a *latitudinal* line similar to those illustrated and explained *in extenso* in the cases relative to the *range line*, the necessary rectifications will be made by the application of similar methods, subject, however, to the proper modifications due to the difference in the direction of the respective lines.

The character of such modifications, when not obvious, are expressed in detail under the various clauses of the several paragraphs of the article on retracements referred to above.

It will also be clearly understood that, in order to avoid unnecessary structural complications, the figures on Plate VII exhibit only the positions of township and section corners after rectification, while in actual practice the quarter section corners will also be properly affected.

Fig. 1. The *east* boundary is assumed as *irregular in bearing and defective in measurement*; the township corners on the same, however, being susceptible of connection by a line *not* deviating more than twenty-one minutes of arc from a true meridian line.

It will be rectified under the rules prescribed by clause 1, paragraph 1, while from the proper corners the *west* and *north* boundaries will be established in the regular manner, as well as the subdivisions within the exteriors thus rectified and established.

Fig. 2. The *east* boundary *defective in measurement*. It will be rectified under clause 1, paragraph 1, while the *west* and *north* boundaries will be established, and the subdivisions executed in the regular manner.

Fig. 3. The *east* boundary *defective in position*. Since the *south* boundary deviates from a true east and west line by *more* than twenty-one minutes of arc, said *east* boundary will be rectified under clause 1, paragraph 1; the *west* and *north* boundaries will be established in the regular manner; and the subdivisions will be executed from *north to south*, and from *east to west*, commencing at the corner to sections 1, 2, 35, and 36, and closing the fractional measurements on the *south* and *west* boundaries, as such closings are made in regular subdivisions on the *north* and *west* boundaries.

Fig. 4. The *east* boundary *defective in alinement*. It will be rectified under clause 2, paragraph 1; while the *west* and *north* boundaries will be established, and the subdivisions executed, in the regular manner.

Fig. 5. The *east* boundary *defective in alinement and measurement*. It will be rectified under clause 2, paragraph 1; the *west* boundary will be rectified in the regular manner, while from the corner common to two townships on the rectified *east* boundary, the *north* boundary will be run west on random and east on true line, permanent corners

-76-

common to sections and quarter sections of the township to be subdivided being established on the same.

The subdivisions will be executed in the regular manner.

Fig. 6. The *south* and *east* boundaries being *defective in alinement, measurement, and position*, will be rectified under clause 1, paragraph 2; the *west* boundary will be established in the regular manner, and the *north* boundary by *east on random*, and west on true line, throwing the fractional measurement against the old *east* boundary; while the subdivisions will be executed from *north to south*, and from *west to east*, commencing at the corner to sections 5, 6, 31, and 32, and closing the fractional measurements on the old *south* and *east* boundaries, as such closings are made in regular subdivisions on the *north* and *west* boundaries.

Fig. 7. The *north, south, east* and *west* boundaries being *defective in alinement, measurement, and position*. The *south*

and *east* boundaries will be rectified under clause 1, paragraph 2; while the west and north boundaries will be retraced for length and bearing, any obliterated old corners being reestablished in their original places.

The subdivisions will be executed as follows:

From the corners to sections 35 and 36, and 25 and 36, the lines between said sections will be extended due north and west, respectively, to their mutual intersection, where the corner to sections 25, 26, 35 and 36, will be established.

From said corner, the line between sections 26 and 35, 27 and 34, 28 and 33, 29 and 32, and 30 and 31 will be projected due west on a true line to its intersection with the west boundary of the township, where a closing corner will be established.

A line thus established is termed a Sectional Correction Line; and when such an auxiliary line, thus projected, intersects its objective limiting line in such proximity to its objective corner that the accessories of the two corners would interfere, that portion of the auxiliary line situated between the last established section corner and the limiting line will be changed in alinement to close upon the corner found, thus avoiding placing two corners in close proximity.

From the initial point of the *sectional correction line*, which, in this case, is the corner to sections 25, 26, 35, and 36, the line between sections 25 and 26, 23 and 24, 13 and 14, 11 and 12, and 1 and 2, will be projected *north on a true line* to its intersection with the north boundary, where a closing corner will be established. A line thus established is termed a SECTIONAL GUIDE MERIDIAN.

South of the sectional correction line, and east of the sectional guide meridian, the subdivisions will be closed upon the south and east boundaries by random and true lines, throwing the fractional measurements against the same, as such closings are made in regular surveys on the north and west boundaries; while that portion of the township situated to the north and west respectively, of said auxiliary lines, will be subdivided in the regular manner, the parallelism of the latitudinal section lines being referred to the sectional correction line, and that of the meridional section lines to the sectional guide meridian.

Closings on the west and north boundaries will be made by random and true lines, when the fallings are less than 50 links per mile, and by true lines run to closing corners when the fallings exceed said limit.

Fig. 8. The *east* boundary defective in *measurement*, the *northern* portion of the same being unchangeable, while the *southern* portion admits of rectification.

The *east* boundary will be rectified under clause 2, paragraph 2, the

-77-

*west* and *north* boundaries will be established, and the subdivisions executed, in the regular manner

Fig. 9. The *east* boundary defective in *alinement* and *measurement*, the *northern* portion thereof being unchangeable, while the *southern* portion of the same admits of rectification.

The *east* boundary will be rectified under clause 3, paragraph 3, the *south* boundary, under clause 1, paragraph 2; the *west* boundary will be established in the regular manner;

while the north boundary will be run *east* on random, and west on true line, throwing the fractional measurement against the *east* boundary.

The subdivisions will be executed from *south* to *north*, and from *west* to *east*, closing the fractional measurements on the *north* and *east* boundaries, as such closings are made in regular surveys, on the north and west boundaries.

Fig. 10. The *east* boundary defective in *measurement*, the *southern* portion thereof being unchangeable, while the *northern* portion admits of rectification.

The *east* boundary will be rectified under clause 4, paragraph 3; while the *west* and *north* boundaries will be established, and the subdivisions executed in the regular manner.

Fig. 11. The *east* boundary defective in *alinement* and *measurement*, the *southern* portion thereof being unchangeable, while the *northern* portion admits of rectification.

The *east* boundary will be rectified under clause 4, paragraph 3; the *west* boundary will be established in the regular manner; the *north* boundary by *east* on true line to closing corner, the fractional measurement being thrown against the old *east* boundary; while the subdivisions will be executed from *north* to *south*, and from *west* to *east*, the fractional measurements being thrown against the old *south* and *east* boundaries, as such closings are made in regular surveys against the north and west boundaries.

Fig. 12. The *east* boundary defective in *measurement*; the *northern* and *southern* portions thereof being unchangeable, while the middle portion admits of rectification.

The *east* boundary will be rectified under clause 1, paragraph 4, the *west* and *north* boundaries will be established, and the subdivisions executed in the regular manner.

Fig. 13. The *east* boundary defective in *alinement* and *measurement*; the *northern* and *southern* portions thereof being unchangeable; while the middle portion admits of rectification.

The *east* boundary will be rectified under clause 1, paragraph 4; the *west* boundary will be established in the regular manner; the *north* boundary by *east* on random and west on true line, the fractional measurement being thrown against the old *east* boundary; while the subdivisions will be executed from *north* to *south* and from *west* to *east*, closing the fractional measurements against the old *south* and *east* boundaries, as such closings are made in regular surveys against the *north* and *west* boundaries.

Fig. 14. The *east* boundary defective in *alinement* and *measurement*; the *northern* and *southern* portions thereof not admitting of rectification in any way, since subdivisional surveys have been closed upon *both* sides of the same; while the middle portion admits of rectification in *measurement*.

The *east* boundary will be rectified under clause 1, paragraph 4; the *west* boundary will be established in the regular manner, the township corner at the end of six miles thereon being *temporarily* established.

-78-

From said temporary corner, the *fractional north* boundary will be run *east* on random to the nearest old established corner on the same, at which point if the falling of the random is *within 50 links per mile*, said boundary will be corrected westward on true line, setting corners common to the sections



and quarter sections on the *north*, at regular intervals from the initial point of the true line, and throwing the consequent fractional measurement in its normal place against the *new west* boundary, while the temporary township corner previously established thereon will be made permanent.

If, however, the falling defined above exceeds the stated limit from the last established corner of the old surveys, the fractional north boundary will be projected *due west* to its intersection with the west boundary, at which point the proper township corner will be permanently established, and the temporary corner destroyed.

In establishing the corners on said north boundary under the latter procedure, the requirements prescribed in the former relative to the allowance for fractional measurement will be strictly observed.

In subdividing, the methods prescribed under Fig. 6 will be applied as far as practicable. The details of the case under consideration are clearly exhibited by fig. 14.

Fig. 15. All of the boundaries are assumed to be defective in *alinement, measurement, and position*; also portions of each as being closed upon by subdivisional surveys and consequently unchangeable relative to the old surveys, while other portions of the same being free from such attachments, admit of rectification.

This figure is constructed on a larger scale than those explained in the preceding paragraphs, in order to illustrate in detail the *modus operandi* to be pursued in rectification, under the rules of the article on retracements applicable to each of the obtaining conditions, and also in subdividing within the rectified exteriors.

## HIATUSES AND OVERLAPS.

[ Plate VIII. ]

The several figures on Plate VIII illustrate in detail the methods to be employed in connecting the unsurveyed portions of two or more township boundaries, when four of such fractional lines, upon being projected towards each other in the direction of the cardinal points by lines not deviating more than twenty-one minutes of arc from true meridian or latitudinal lines, do not form a common intersection.

Said methods, in addition to the reasons embodied in the article entitled "Explanations of Articles," etc., page 71, are based upon the following desiderata, viz:

1. The adjustment of such township boundaries so as to maintain section 36 in a condition theoretically and practically perfect, according to the requirements of the rectangular system of surveying.

2. That in accomplishing the above, the resultant fractional excess or deficiency (which for brevity of explanation is termed "the rectangular fraction") will be thrown into, or taken out of section 6, whenever practicable.

3. That all incidental fractional measurements developed in the establishment of township boundaries or subdivisional lines by such methods shall be thrown against the old surveys whenever practicable.

In considering said methods it will be observed that the conditions

to be dealt with are either hiatuses or overlaps, the former possessing three characteristic features, which are named as follows:

Simple hiatus. See figures 1 and 2.

Meridional hiatus. See figure 3.

Latitudinal hiatus. See figure 4; while overlaps are shown by figure 5.

As the application of said methods, when the conditions exhibited obtain, gives similar results with but a few exceptions, which will be specifically detailed hereafter, the condition represented by A, figure 3, will be considered and the method of connection described as an example, upon the following assumptions, viz:

That, of the boundaries of townships 1 and 2 north, ranges 3 and 4 west, those portions indicated by broken lines are *unsurveyed*;

That it is required to connect said portions in order to complete the subdivisions in one or more of the townships.

Beginning at the established terminal corners on the *south* and *east* boundaries of T. 2 N., R. 4 W., *blank* lines will be projected due east and due south, respectively, with temporary stakes at intervals of ten chains, to an intersection, which point will be marked by a temporary stake;

Then, from the established terminal corners on the *west* and *north* boundaries of T. 1 N., R. 3 W., *true* lines will be projected due north and due west, respectively, with regular corners for two sections and quarter sections, to an intersection, which point will be marked by a temporary stake;

Then, by proper measurements, the character of the resulting condition will be determined, and by comparison with diagrams A, of the figures on Plate VIII, the particular method of connection will be obtained and applied.

Said condition in the case under consideration, it will be observed, is a "*meridional hiatus*"; therefore, from the temporary stake marking the intersection of the extended south and east boundaries of T. 2 N., R. 4 W., which will be replaced by a permanent corner (common to two townships) for T. 1 N., R. 3 W., and T. 2 N., R. 4 W., the south boundary of the latter will be extended due east to its intersection with the west boundary of the former, where a corner for (one township only) T. 1 N., R. 4 W., will be permanently established;

Then, from the corner for T. 1 N., R. 3 W., and T. 2 N., R. 4 W., the south and east boundaries of the latter will be corrected back west and north, respectively, on true lines, establishing regular corners common to two quarter sections and sections of said township, to the initial points of the blank lines, against which the resulting fractional measurements will be thrown, while the stakes temporarily established on the blank lines at intervals of ten chains will be destroyed;

Then, from the stake temporarily marking the intersection of the north and west boundaries of T. 1 N., R. 3 W., which will be destroyed, the former boundary will be extended due west to its intersection with the east boundary of T. 2 N., R. 4 W., where a proper closing corner will be established, the resulting fractional measurement thrown against the same, and the distance to the nearest corner on said boundary carefully determined and recorded in the field notes.

Thus section 36 is made *full*, serving as a perfect base from which to initiate the subdivisional work in T. 2 N., R. 4 W.;

the "rectangular fraction," which in this case indirectly represents an excess, is incorporated in section 6, which being lotted on two sides in its normal con-

-80-

dition, absorbs the excess without deranging materially those portions of the same usually defined as regular subdivisions; while the unsurveyed portions of the entire group of townships are arranged in such a manner as to admit of completing the subdivisional work therein on the approved rectangular basis.

Relative to incorporating an excess in, or supplying a deficiency from, section 6, *simple hiatuses* are noted as exceptions to the general rule; therefore, when such hiatuses are square, or longer meridionally (see 1, diagrams A, fig. 1), the "rectangular fraction" will be taken out of section 31, and incorporated in section 1; but if the length thereof (see 1, diag. A, fig. 2) lie in a latitudinal direction, said "rectangular fraction" will be taken out of section 1 and incorporated in section 31.

If the surveys contemplated, within a group of four townships, consist of the completion of the southeast unsurveyed portion of the north-west township only, the method detailed in the foregoing paragraphs will be employed in all particulars, with the exception that the extension of the north and west boundaries of the southeast township will be omitted; but the completion of the unsurveyed portions of any of the other three demands of the deputy surveyor the performance of the whole operation, and the complete connection of all the boundaries.

When, of four township boundaries whose directions tend to an approximate common point, two of the same have been carried to a mutual intersection, and are closed upon by subdivisional and other lines (see paragraph 2, article on "Retracements," etc.,) the unsurveyed portion of the remaining boundaries will be connected with them by the application of these methods, sufficiently modified to preserve intact the prior subdivisional surveys.

### FRAGMENTARY SUBDIVISION.

Plate IX illustrates the general methods to be employed in the execution of fragmentary subdivisions within townships, portions of which have been subdivided from fractional township boundaries extended from various directions and not connected with each other.

These conditions obtain to a large extent in mountainous regions, where in accordance with the existing provisions, relative to the survey of agricultural lands, in the acts of Congress making appropriations for public land surveys, such surveys are extended along the valley and bottom lands, leaving the mountainous areas unsurveyed at the time of the execution of the original work; but which, at a later date, in view of other considerations are placed under contract for survey.

It is obvious that the number and character of such cases would be too great and varied to be considered in detail; therefore, when the deputy surveyor meets with a case which is not covered exactly by these instructions, or the special instructions from the surveyor general, his thorough under-

standing of the preceding articles on this subject, and of the conditions illustrated on Plates VI and VIII, it is expected will point out to him the proper method to be employed.

It is possible, however, that cases may arise so complex in their character as to produce a feeling of doubt relative to the proper solution of the problem; in which case he will at once communicate with this office through the surveyor general, submitting information, by *letter* and *diagrams*, of the exact condition as found by him, and the necessary instructions will be forwarded as soon as practicable.

NOTE.—A quarter section is held to be surveyed only when three of its corners have been officially established.

-81-

### GEOGRAPHICAL POSITIONS OF BASE LINES AND PRINCIPAL MERIDIANS GOVERNING THE PUBLIC SURVEYS.

The system of rectangular surveying, authorized by law May 20, 1785, was first employed in the survey of United States public lands in the State of Ohio.

The boundary line between the States of Pennsylvania and Ohio, known as "Ellicotts line," in longitude  $80^{\circ} 32' 20''$  west from Greenwich, is the meridian to which the first surveys are referred. The *townships* east of the Scioto River, in the State of Ohio, are numbered from south to north, commencing with No. 1 on the Ohio River, while the *ranges* are numbered from east to west, beginning with No. 1 on the east boundary of the State, except in the tract designated "U. S. military land," in which the townships and ranges are numbered, respectively, from the south and east boundaries of said tract.

During the period of one hundred and nine years since the organization of the system of rectangular surveying, numbered and locally named principal meridians and base lines have been established, as follows:

*The first principal meridian* begins at the junction of the Ohio and Big Miami rivers, extends north on the boundary line between the States of Ohio and Indiana, and roughly approximates to the meridian of longitude  $84^{\circ} 48' 50''$  west from Greenwich. The ranges of the public surveys in the State of Ohio, west of the Scioto River, are, in part, numbered from this meridian. For further information in regard to numbering of townships and ranges of the early surveys in Ohio, the reader is referred to the State map prepared in the General Land Office.

*The second principal meridian* coincides with  $86^{\circ} 28'$  of longitude west from Greenwich, starts from a point two and one half miles west of the confluence of the Little Blue and Ohio rivers, runs north to the northern boundary of Indiana, and, with the base line in latitude  $38^{\circ} 28' 20''$ , governs the surveys in Indiana and part of those in Illinois.

*The third principal meridian* begins at the mouth of the Ohio River and extends north to the northern boundary of the State of Illinois, and with the base line in latitude  $38^{\circ} 28' 20''$ , governs the surveys in the State east of the third principal meridian, with the exception of those projected from the *second principal meridian*, and the surveys on the west, to the Illinois River. This meridian is nearly coincident with  $89^{\circ} 10' 15''$  of west longitude from Greenwich.

*The fourth principal meridian* begins at a point on the right bank of the Illinois River, in latitude 40° 00' 30" north, and longitude 90° 28' 45" west from Greenwich, and with the base line running west from the initial point, governs the surveys in Illinois west of the Illinois River and west of that part of the *third principal meridian* which lies north of the river.

The fourth principal meridian also extends north through Wisconsin and northeastern Minnesota, and, with the south boundary of Wisconsin as its base line, governs all the surveys in the former and those in the latter State lying east of the Mississippi River, and the third guide meridian west (of the fifth principal meridian system), north of the river.

*The fifth principal meridian* starts from the old mouth of the Arkansas River, and with the base line running west from the old mouth of the St. Francis River, governs the surveys in Arkansas, Missouri, Iowa, North Dakota; those in Minnesota, west of the Mississippi River and west of the third guide meridian north of the river; and in South Dakota

-82-

all east of the Missouri River, and the surveys on the west side of the river to a limiting line following the third guide meridian (of the sixth principal meridian system), White River, and the west and north boundaries of the Lower Brule Indian Reservation. This meridian is nearly coincident with 91° 03' 42" longitude west from Greenwich.

*The sixth principal meridian*, which is approximately the meridian of 97° 23' west longitude from Greenwich, extends from the base line coincident with the north boundary of Kansas in latitude 40° north, *south* through the State to its south boundary, in latitude 37° north, and *north* through Nebraska to the Missouri River; and governs the surveys in Kansas and Nebraska; the surveys in Wyoming, except those referred to the *Wind River meridian* and base line, which intersect in latitude 43° 01' 20" north, and longitude 108° 48' 40" west from Greenwich; the surveys in Colorado, except those projected from the *New Mexico* and *Ute meridians*, the latter intersecting its base line in latitude 39° 06' 40" north and longitude 108° 33' 20" west from Greenwich; and the surveys in South Dakota extended, or to be extended, over the tract embracing the Pine Ridge and Rosebud Indian reservations.

In addition to the above mentioned *numbered* principal meridians, other principal meridians with *local names* have been established, as follows:

*The Michigan meridian*, in longitude 84° 22' 24" west from Greenwich, with a base line in latitude 42° 26' 30" north (eight miles north of Detroit), governs the surveys in Michigan.

*The Tallahassee meridian*, in longitude 84° 16' 42" west from Greenwich, runs north and south from the initial point on the base line at Tallahassee, in latitude 30° 28' north, and governs the surveys in Florida.

*The Saint Stephens meridian*, in longitude 88° 02' west from Greenwich, begins at the initial point (Ellicott's corner), on the base line, in latitude 31° north, extends south to Mobile Bay and north to latitude 33° 06' 20", and governs the surveys in the southern district of Alabama, and in Pearl River district lying east of the river and south of the Choctaw

base line, in latitude 31° 52' 40" north, in the State of Mississippi.

*The Huntsville meridian* begins on the northern boundary of Alabama, in latitude 34° 59' north, longitude 86° 34' 45" west from Greenwich, extends south to latitude 33° 6' 20" north, and governs the surveys in the northern district of Alabama.

*The Choctaw meridian* begins on the Choctaw base line, latitude 31° 54' 40" north, longitude 90° 14' 45" west from Greenwich, runs north to the south boundary of the Chickasaw cession, in latitude 34° 19' 40" north, and governs the surveys east and west of the meridian, and north of the base line.

*The Chickasaw meridian* begins on the north boundary of Mississippi in latitude 34° 59' north, longitude 89° 15' west from Greenwich, extends south to latitude 33° 48' 45" north, and governs the surveys in north Mississippi.

*The Washington meridian* begins on the base line in latitude 31° north, longitude 91° 9' 15" west from Greenwich, extends north to the Mississippi River, and governs the surveys in the southwestern angle of the State of Mississippi.

*The Saint Helena meridian* begins at the initial point of the *Washington meridian*, in latitude 31° north, and longitude 91° 09' 15" west of Greenwich, extends south to the Mississippi River, and governs the sur-

-83-

veys in the Greensburg and southeastern districts of Louisiana, east of the Mississippi River.

*The Louisiana meridian*, in longitude 92° 24' 15" west of Greenwich, extends from the Gulf of Mexico to the north boundary of Louisiana, and, with the base line through the initial point, conforming to the parallel of 31° north latitude, governs all the surveys in the state west of the Mississippi River.

*The New Mexico meridian*, in longitude 106° 53' 40" west from Greenwich, extends through the Territory, and with the base line, in latitude 34° 15' 25" north, governs the surveys in New Mexico, *except* those in the northwest corner of the territory, referred to *Navajo meridian* and base line, which have their initial point in latitude 35° 45' north, longitude 108° 32' 45" west from Greenwich.

*The Salt Lake meridian*, in longitude 111° 54' 00" west from Greenwich, has its initial point at the corner of Temple Block, in Salt Lake City, Utah, extends north and south through the Territory, and, with the base line, through the initial, and coincident with the parallel of 40° 46' 04" north latitude, governs the surveys in the Territory, *except* those referred to the *Uintah meridian* and base line projected from an initial point in latitude 40° 26' 20" north, longitude 109° 57' 30" west from Greenwich.

*The Boise meridian*, longitude 116° 24' 15" west from Greenwich, passes through the initial point established south 29° 30' west, nineteen miles distant from Boise City, extends north and south through the State, and, with the base line in latitude 43° 46' north, governs the surveys in the State of Idaho.

*The Mount Diablo meridian*, California, coincides with the meridian of 121° 55' 48" west from Greenwich, intersects the base line on the summit of the mountain from which it takes

its name, in latitude 37° 51' 30" north, and governs the surveys in the State of Nevada, and the surveys of all central and northern California, *except* those belonging to the Humboldt meridian system.

*The Humboldt meridian*, longitude 124° 8' west from Greenwich, intersects the base line on the summit of Mount Pierce, in latitude 40° 25' 12" north, and governs the surveys in the northwestern corner of California, lying west of the Coast range of mountains, and north of township 5 south, of the *Humboldt meridian system*.

*The San Bernardino meridian*, California, longitude 116° 56' 15" west from Greenwich, intersects the base line on Mount San Bernardino, latitude 34° 07' 10" north, and governs the surveys in southern California, lying *east* of the meridian, and that part of the surveys situated *west* of it which is *south* of the eighth standard parallel south, of the *Mountain Diablo meridian system*.

*The Willamette meridian*, which is coincident with the meridian of 122° 44' 20" west from Greenwich, extends *south* from the base line, in latitude 45° 31' north, to the north boundary of California, and *north* to the international boundary, and governs all the public surveys in the States of Oregon and Washington.

*The Black Hills meridian*, longitude 104° 03' west from Greenwich, with the base line in latitude 44° north, governs the surveys in the State of South Dakota, north and west of White River, and west of the Missouri River (between latitudes 45° 55' 20" and 44° 17' 30"), the north and west boundaries of the Lower Brule Indian Reservation, and the west boundary of range 79 west, of the fifth principal meridian system.

*The Montana meridian* extends north and south from the initial

-84-

monument on the summit of a limestone hill, eight hundred feet high, longitude 111° 38' 50" west from Greenwich, and with the base line on the parallel of 45° 46' 48" north latitude, governs the surveys in the State of Montana.

*The Gila and Salt River meridian* intersects the base line on the south side of Gila River, opposite the mouth of Salt River, in latitude 33° 22' 40" north, longitude 112° 17' 25" west from Greenwich, and governs the surveys the Territory of Arizona.

*The Indian meridian*, in longitude 97° 14' 30" west from Greenwich, extends from Red River to the south boundary of Kansas, and with the base line in latitude 34° 30' north, governs the surveys in the Indian Territory, and in Oklahoma Territory all surveys east of 100° west longitude from Greenwich.

*The Cimarron meridian* in longitude 103° west from Greenwich, extends from latitude 36° 30' 37" north, and with the base line in latitude 36° 30' north, governs the surveys in Oklahoma Territory west of 100° west longitude from Greenwich.

## DECLINATION OF THE MAGNETIC NEEDLE

For the following article, with tables, charts, and their explanation, relating to the use of the compass in surveying,

the Commissioner of the General Land Office is indebted to Dr. T. C. Mendenhall, Superintendent of the U. S. Coast and Geodetic Survey. It was furnished at the request of the Commissioner.

The paper, originally written in 1878 by Assistant C. A. Schott, chief of the computing division, has been revised and enlarged by him in order to present the latest information on the subject in possession of the C. and G. Survey, June, 1893. It is also accompanied by three charts taken from the C. and G. Survey report for 1889 and amended to date; they show the distribution of the magnetic declination for the year 1890, and in connection with the tables, for any year within their range.

This paper takes the place of the chapter commencing at the foot of page 25 and ending in the middle of page 29 of the "Manual of Instructions to Surveyors General of the United States" printed in 1871, part of which in the course of time had become obsolete. The present article will be found of great interest and value as an aid in the prosecution of the surveys of the public lands.

## AN ACCOUNT OF THE PRESENT GEOGRAPHICAL DISTRIBUTION AND OF THE ANNUAL CHANGE OF THE MAGNETIC DECLINATION<sup>64</sup> WITHIN THE LIMITS OF THE UNITED STATES.

*Introductory remarks.*—The magnetic declination at any place is the angle contained between two vertical planes, one being that of the astronomical or true meridian of the place and the other the plane in which the axis of a freely suspended horizontal magnetic needle lies at the time. The former is a fixed plane, the latter is variable, as is shown by the regular or irregular, and the greater or less oscillations of a needle when delicately suspended; these fluctuations are subject to different laws depending on geographical position. Since the magnetic

-85-

declination is found to vary with respect to place and time, it is necessary on the part of the observer to give with his statement of the declination the geographical position or the latitude and longitude<sup>65</sup> of his station (expressed to the nearest minute of arc will suffice in general), and to accompany the record by the local time when the observation was made; the nearest hour (or quarter of an hour) should be stated, also whether sidereal time, mean time, local, or standard time is used.

The declination is called "west" when the north-seeking end of the magnet or needle points to the westward of the true meridian, and is called "east" when the same end points to the eastward. Roughly speaking, the north end of a needle tends approximately towards the geographical north, or, rather towards a region which surrounds the magnetic pole, situated in the vicinity of King William Land, and supposed to be in about latitude 70½° and longitude 100° W. Here the

64. Commonly known as the variation of the compass; in scientific treatises on terrestrial magnetism the term magnetic declination is always employed, in order to avoid any confusion which would arise when treating of such motions of the needle as the diurnal, annual, and secular variations.

65. Reckoned from Greenwich westward to 180°.

horizontal needle has lost its directive force, and the dip needle will point vertically up and down; in other words, at the pole the magnetic and gravitational forces agree in direction. The magnetic declination presents great extremes in value within the limits of the United States; thus for the year 1893, we have at Eastport, Me., 19° W.; at the north-eastern end of Lake Michigan, at the west end of Lake Erie, and in St. Helena Sound, S. C., 0° (needle pointing due north); at Galveston, Tex., 7½° E.; at San Diego, Cal., 13¼° E.; at Cape Flat-tery, Wash., 23° E.; at Sitka Alaska, 29° E.; the maximum of 43½° E. is reached at the mouth of Firth River, near where the meridional boundary line of 141° strikes the Arctic Ocean; at Bering Strait, the declination has diminished to 21° E., and at the extreme western point of our territory, at Attu Island, it is but 8½° E. The general distribution of the declination (for the given epoch, 1890), is shown by the isogonic charts appended to this manual, taken from the Coast and Geodetic Survey Report for 1889, Appendix No. 11; they are reproduced and amended to bring them up to the present state of our knowledge, and appear here transferred to the new base map of 1893 (scale 1/7,000,000). The third chart referred to appears for the first time in the manual, it represents the magnetic meridians, i. e. lines which show directly the direction of the needle, this being a tangent to the curve at any point in it. These curves, therefore, may be said to represent a physical fact, while the isogonic curves are wholly artificial, but better adapted for practical application. The meridional system converges toward the magnetic pole without any special relation to the geographical pole, whereas in the isogonic system all curves must pass through the latter pole as well. It is a matter of great importance for surveyors to recognize the fact of the local deviations from the general trend of the isogonic lines; these local irregularities of the distribution are more conspicuous in regions of igneous rocks, but they appear also in regions of sedimentary deposits, the intensity of the disturbance depending on that of the local cause and its depth below the surface. The disturbing local poles or ridges are in general of the same polarity as that of the north magnetic pole. Disturbed regions may range from a fraction of a square mile to hundreds of square miles, but as yet little has been done in this inviting field for research.

In consequence of the secular variation of the declination the magnetic charts require to be reconstructed from time to time, though for a few years from the date of an isogonic chart the declination for any

-86-

position can readily be assigned by means of our knowledge of the annual change, which is sufficiently constant for a few years to produce no appreciable error. The secular variation is by far the greatest of the great number of changes in the direction of the needle. Thus at Albany, N. Y., the declination changed from 12° W. in the year 1650 to nearly 5½° W. about the year 1795, and is now again about 10¾° W.; at New York the change was similar; at Baltimore, Md., the declination changed from nearly 6° W. about 1680 to nearly ½° W. in 1802, the present value being near 5° W.; at San Diego, Cal., the declination was about 7½° E. in 1710, and is now a little over 13° E.; at Chamisso Island, Kotzebue Sound, Alaska, the

declination was 33½° E. in 1750, but is now only 26½° E. The results of the latest investigation of this subject published by the Survey are contained in Appendix No. 7, Coast and Geodetic Survey Report for 1888. What is known as the *annual change* of the declination is nothing else than the effect of the secular variation during one year, and must be carefully distinguished from the *annual variation*, which has but a small range and depends on the season of the year.

The *isogonic and magnetic meridian charts*.—Referring to the two isogonic charts appended to this article, the larger comprises the compact area of the United States and the smaller one the territory of Alaska. If for any selected epoch we connect by curves all positions at which the needle was observed to have the same given declination, we trace out an isogonic curve for that value of declination. On the charts they are laid down for the equal difference of 1, with every fifth curve drawn heavier for better distinction, and they answer to the epoch January 1, 1890. For their construction more than 3,200 observed declinations (reduced to epoch) were employed, the latest observation only being used at stations occupied more than once. The isogonic curve of zero declination, also called the agonic line, at which the needle points due north and south, is seen to pass from the island of Michipicoten to the extreme west end of Lake Erie and close to Charleston, S. C., where it leaves the coast and turns toward the Bahama Islands. This curve has been conveniently used as a representative line to markout the changes which in the course of time the magnetic system in its vicinity undergoes.

On the Atlantic coast it reached its highest position<sup>66</sup> near Cape Henry, Va., about the year 1800 and has since been moving southward. All localities to the northeast of this line have *west* declination, indicated by a + sign to the index number; localities to the westward of it and comprising the greater part of the United States have now *east* declination, as marked by a negative index. To take up the declination for any given position on this chart, we resort to simple graphical interpolation; it is best done by dropping a perpendicular (curved) from the position to the nearest isogonic on either side of it and measuring the length of the shorter one, also that of the two together; the proportion of the distance with respect to the whole difference of 60' is readily ascertained. The result answers to the year 1890 (January), and by applying the effect of the annual change, as tabulated further on, the declination may be had for any time before or after that epoch. This annual change is at present manifested by the apparent movement of the isogonic lines to the southward or downward along the Atlantic coast and to the westward or left on the Gulf coast and in the interior to the north of it; on the Pacific coast this movement has

-87-

either ceased or is very inconspicuous at present. The charts show two shaded bands, one crossing the northern part of Maine where the direction of the needle has reached a limiting *westerly* position and is about ready to reverse its secular motion; the other band skirts the Pacific coast from Washington to Point Conception, Cal., where it passes out to sea. Here

66. See Plate No. 25, Appendix No. 7, Coast and Geodetic Survey Report for 1888.

the needle is about stationary at the easterly limit of its grand secular swing. For intermediate points this same condition was reached at corresponding times during the present century.

It will be seen that the irregularities in the local distribution of magnetism can only be brought out and specially delineated by a large addition to the observations so far accumulated.<sup>67</sup>

The degree of accuracy of the charts depends in the first place on that of the original observation, secondly on that of the change in the interval between observation and epoch, and lastly on the density of observations about the locality or the degree of generalization required in the construction of the curves. The meridional chart has already been sufficiently explained and the additional dip and intensity curves shown on it do not come within the scope of this paper.

*The secular variation of the magnetic declination.*—This variation, as already pointed out, is a matter of great importance to the surveyor who is frequently called upon to recover or re-run old compass lines or to decide between conflicting claims as to position of old boundary lines originally traced out by compass but lost or obliterated in the course of time. As its name implies, this angular motion extends over so long a period and is so utterly unknown as to its origin that the recognition of its law is a matter of much difficulty and uncertainty. To represent it a periodic function is employed; but from this it should not be inferred that the motion is repeated at stated intervals; on the contrary we are fully aware of the complexity of the phenomenon and of the necessity of continually watching year by year the changes resulting from observations and correcting or remodeling our analytical representations accordingly. It should be fully understood that this process is a wholly tentative one and that the mathematical inferences due to the *form* of the function are not meant thereby to represent or become a physical reality. Thus we are forced to reconstruct our secular change tables at suitable intervals. The period found most in accord with observations is about 250 years with variations of about 50 years longer or shorter, at various stations. This holds only for the United States. The earlier setting in of the secular variation phases in the east and spreading westward over the country has already been referred to; for instance the easternmost position or eastern elongation occurred at places in eastern Maine about the year 1760, this phase reached the Hudson River about 1790, the Mississippi River about 1820, Salt Lake about 1870, and the west coast, as at San Francisco Bay, probably next year or not far from it. Whether this phenomenon will be repeated with the present incoming opposite phase in northern Maine remains to be seen. The results from a discussion of 1,062 observations at 94 stations are given in the following table of decennial values, and after 1850 for 5-year intervals. The average number of observations for each station is 11.

*Table of the secular variation of the magnetic declination at stations in the United States, computed by means of periodic functions and based*

upon all available observations from the earliest to the present time.—The table is subdivided into three groups, viz: Group I comprises the stations located east of the Apalachian Range, and the Atlantic coast from Maine to Florida, inclusive; Group II, the stations situated between the Rocky Mountains and the Apalachian Range, from Canada to the Gulf; Group III contains the stations located between the Rocky Mountains and the Pacific coast, from California to Washington, also those in Alaska. Within each group the stations are arranged in the order of their latitudes.

The tabular values are of various degrees of accuracy, as is indicated by the entry, giving either whole degrees, or degrees and tenths, or degrees, tenths, and hundredths—the latter relatively the most reliable. The results, dating back to the seventeenth century, are in many cases but approximations more or less reliable. *West* declination is indicated by the sign + prefixed, *east* declination by the sign – prefixed. All values for 1900 are mere rough predictions and depend upon the precarious supposition of a continuation of the law implied by the formulæ.

*(The remainder of page 88 and pages 89 through 137 are deleted. They contain the following Tables and technical information.)*

Pages 88-95; Tables B, C, D; *Secular Variation of Magnetic Declination.*

Pages 96 and 97; Table E; *Latitude and Longitude of places of Magnetic Observation.*

Pages 98-101; Table F; *Approximate average Annual Change of Magnetic Declination* Table G; *finding mean Declination; and the use of these tables.*

Pages 102-119; Tables H, J, K, I and II; *are tables for Polaris observations. Instructions are given for their use in observing the star to determine a true meridian.*

Pages 120-137; Table III, *Aximuths of the Secant; Table IV, Azimuths of the Tangent; Table V and VI, Offsets from the Tangent to the Parallel; Table VII, Correction of Random Lines; Tables VIII and IX, Length of a Degree of Latitude and Degree of Longitude. Table X, Convergency of Meridians. Instructions for use of these table and related subject matter is discussed.)*

67. The results of any new and satisfactory observation sent to the Superintendent of the Coast and Geodetic Survey will be duly credited in a subsequent publication.

NO. 1.

[ Third Page. ]

TITLE PAGE.

[See Plate II.]

FIELD NOTES

OF THE SURVEY OF THE

THIRD STANDARD PARALLEL NORTH

THROUGH

Ranges Nos. 21, 22, 23, and 24 East

OF THE

PRINCIPAL BASE AND MERIDIAN

IN THE

STATE OF MONTANA,

AS SURVEYED BY

RICHARD ROODS,

U. S. DEPUTY SURVEYOR,

UNDER HIS CONTRACT NO. 97,  
DATED JULY 10, 1890.

*Survey commenced August 22, 1890.*

*Survey completed August 29, 1890.*

-139-

-140-

[ Second page. ]

NAMES AND DUTIES OF ASSISTANTS.

PETER LONG	Chainman.
JOHN SHORT	Chainman.
ELI MARKER	Chainman.
WILLIAM TALLY	Chainman.
LEWIS LINK	Chainman.
HENRY CLAY	Moundman.
WILLIAM STONE	Moundman.
ADAM DULL	Axman.
JAMES BANNER	Flagman.

PRELIMINARY OATHS OF ASSISTANTS.

We, Peter Long, John Short, Eli Marker, and William Tally, do solemnly swear that we will well and faithfully execute the duties of chainmen; that we will level the chain upon even and uneven ground, and plumb the tally pins, either by sticking or dropping the same; that we will report the true distances to all notable objects, and the true lengths of all lines that we assist in measuring, to the best of our skill and ability, and in accordance with instructions given us, in the survey of the Third Standard Parallel North, through Ranges Nos. 21, 22, 23, and 24 East, of the Principal Base and Meridian, in the State of Montana.

PETER LONG, *Chainman*  
JOHN SHORT, *Chainman*  
ELI MARKER, *Chainman.*  
WILLIAM TALLY, *Chainman.*

Subscribed and sworn to before me this second day of August, 1890.

[SEAL.]

WILLIAM MARTIN,  
*Notary Public.*

We, Henry Clay and William Stone, do solemnly swear that we will well and truly perform the duties of moundmen, in the establishment of corners, according to the instructions given us, to the best of our skill and ability, in the survey of the Third Standard Parallel North, through Ranges Nos. 21, 22, 23, and 24 East, of the Principal Base and Meridian, in the State of Montana.

HENRY CLAY, *Moundman*  
WILLIAM STONE, *Moundman.*

Subscribed and sworn to before me this second day of August, 1890.

[SEAL.]

WILLIAM MARTIN,  
*Notary Public.*

We, George Sharp and Adam Dull, do solemnly swear that we will well and truly perform the duties of axmen, in the establishment of corners and other duties, according to instructions given us, and to the best of our skill and ability, in the survey of the Third Standard Parallel North, through Ranges Nos. 21, 22, 23, and 24 East, of the Principal Base and Meridian, in the State of Montana.

GEORGE SHARP, *Axman*  
ADAM DULL, *Axman.*

Subscribed and sworn to before me this second day of August, 1890.

[SEAL.]

WILLIAM MARTIN,  
*Notary Public.*

I, James Banner, do solemnly swear that I will well and truly perform the duties of flagman, according to instructions given me, to the best of my skill and ability, in the survey of the Third Standard Parallel North, through Ranges Nos. 21, 22, 23, and 24 East, of the Principal Base and Meridian, in the State of Montana.

JAMES BANNER, *Flagman.*

Subscribed and sworn to before me this second day of August, 1890.

[SEAL.]

WILLIAM MARTIN,  
Notary Public.

54.10  
71.55

I, Lewis Link, do solemnly swear that I will well and faithfully execute the duties of chainman; that I will level the chain upon even and uneven ground, and plumb the tally pins, either by sticking or dropping the same; that I will report the true distances to all notable objects, and the true length of all lines that I assist in measuring, to the best of my skill and ability, and in accordance with instructions given me, in the survey of the Third Standard Parallel North, through Ranges Nos. 23 and 24 East, of the Principal Base and Meridian, in the State of Montana.

LEWIS LINK, Chainman.

Subscribed and sworn to before me this twenty-seventh day of August, 1890.

[SEAL.]

RICHARD ROODS,  
U. S. Deputy Surveyor.

dist.; and raise a mound of earth, 3½ ft. base, 1½ ft. high, N. of cor.

Samuel Somer's house bears N. 65° E.

Leave prairie, enter Somer's field, bears N. and S.

Leave field, enter prairie, bears N. and S.; field extends N. to Somer's house, and S. about 15 chs.

Difference between measurements<sup>72</sup> of 80.00 chs. by two sets of chainmen, is 6 lks.; position of middle point  
By 1st set, 79.97 chs.

By 2nd set, 80.03 chs.; the mean of which is

80.00

Set a limestone, 24 x 9 x 6 ins., 18 ins. in the ground, for standard cor. of secs 31 and 32,<sup>73</sup> marked S. C. on N., with 5 grooves on E. and 1 groove on W. faces; dig pits 24 x 18 x 12 ins., crosswise on each line, E. and W., 3 ft., and N. of stone, 7 ft. dist.; and raise a mound of earth, 4 ft. base, 2 ft. high, N. of cor.

Samuel Somer's house bears N. 38° W.

Land, gently rolling prairie.

Soil, sandy loam; 1st rate.

No timber.

-143-

Third Standard Parallel North, through Range 21 East—  
Continued.

-142-

Third Standard Parallel North, through Range 21 East.

Chains.	Survey commenced August 22, 1890, and executed with a W. & L. E. Gurley light mountain transit, No. _____, the horizontal limb having two double verniers placed opposite to each other and reading to 30" of arc.
	The instrument was examined, tested on the true meridian at Helena, found correct, and was approved by the surveyor general for Montana, August 1, 1890.
	I begin at the standard corner of townships 13 north, ranges 20 and 21 east, which is a sandstone, 8 x 7 x 5 ins. above ground, firmly set, and marked and witnessed as described by the surveyor general.
	At a point 3.39 ft. <sup>68</sup> south of said standard corner, in latitude 45° 34' 5 N., longitude 107° 54' W., <sup>69</sup> at 9 <sup>h</sup> . 19 <sup>m</sup> . p. m., by my watch, which is 2 minutes fast of local mean time, I observe Polaris at <i>eastern elongation</i> , in accordance with instructions <sup>70</sup> in the Manual, and mark the line thus determined, by a tack driven in a wooden plug set in the ground, five chains north of my station.
	August 22, 1890.
	August 23, 1890: At 6 a. m., I lay off the azimuth of Polaris, 1° 49' 6", to the west, and mark the TRUE MERIDIAN thus determined, by cutting a mark on a stone firmly set in the ground, west of the point established last night; the <i>magnetic</i> bearing of said true meridian is N. 18° 13' W., which reduced by the table on page 100 of the Manual, gives the <i>mean magnetic declination</i> , 18° 09' east.
	At this station (i. e., the point 3.39 ft. S. of the standard cor.), I turn off from the <i>true meridian</i> , an angle <sup>71</sup> of 89° 57' 20".9 toward the east, and run N. 89° 57' E. on the secant, S. of sec. 31.
28.10	Over gently rolling prairie. Indian trail, bears N. 28° E. and S. 28° W.
	Difference between measurements of 40.00 chs., by two sets of chainmen, is 4 lks.; position of middle point By 1st set, 40.02 chs. By 2nd set, 39.98 chs.; the mean of which is
40.00	N. 1.53 ft. from the secant, Set a limestone, 20 x 8 x 5 ins., 15 ins. in the ground, for standard ¼ sec. cor., marked S. C. ¼ on N. face; dig pits 18 x 18 x 12 ins., E. and W. of stone, 3 ft.

Chains.	
	N. 89° 58' E. on the secant, through sec. 32. Over gently rolling prairie.
3.20	Road from Lake City to Ashland, bears N. 30° W. and S. 30° E.
12.40	Leave prairie, bears N. 25° W. and S. 25° E.; begin descent.
17.50	Pine Creek, 50 lks. wide, 40 ft. below prairie, course S. 20° E.; clear water 5 ft. deep; rapid current, gravelly bottom; bank 10 ft. high.
19.40	Top of bluff bank 25 ft. high, bears N. 20° W. and S. 20° E.; enter heavy pine timber and begin steep ascent, over stony ground, sloping N. W.
	Difference between measurements of 40.00 chs., by two sets of chainmen, is 24 lks.; position of middle point By 1st set, 39.88 chs. By 2nd set, 40.12 chs.; the mean of which is
40.00	S. 1.19 ft. from the secant, Set a granite stone, 14 x 8 x 6 ins., 9 ins. in the ground, for standard ¼ sec. cor., marked S. C. ¼ on N. face; from which A pine 16 ins. diam., bears N. 37½° E., 48 lks. dist., marked S. C. ¼ S. B. T. A pine, 14 ins. diam., bears N. 42° W., 51 lks. dist., marked S. C. ¼ S. B. T.
54.00	Leave heavy timber, bears N. and S.
74.00	Top of high granite ridge, 320 ft. above Pine Creek, bears N. E. and S. W.
	Difference between measurements of 80.00 chs., by two sets of chainmen, is 22 lks.; position of middle point By 1st set, 80.11 chs. By 2nd set, 79.89 chs.; the mean of which is
80.00	S. 2.04 ft. from the secant,

68. Interpolated by simple proportion for the given latitude, from the second column of Table III, page 121.

69. The latitude and longitude will be given by the surveyor general, in his special written instructions.

70. See directions for making the observation, page 105.

71. This angle is interpolated by simple proportion, for the given latitude, from the column headed "3 miles" in Table IV. But hereafter the exact angle required will be changed to the nearest angle that can be set off or read on the instrument used.

72. The measurements are counted from the beginning of the mile; 40.00 chs. are measured from the last ¼ sec. cor.; see "Base Line," par. 6, page 51.

73. At this point, the secant intersects the standard parallel. See Plate II, figs. 1 and 2.



Set a granite stone, 20 x 8 x 4 ins., 15 ins. in the ground, for Standard Cor. of secs. 32 and 33, marked S. C., on N., with 4 grooves on E. and 2 grooves on W. faces; and raise a mound of stone, 2 ft. base, 1 1/2 ft. high, N. of cor. Pits impracticable.  
 NOTE.—I erect a signal at this corner for a test sight from one of the high points visible to the east.  
 Land, mountainous.  
 Soil, stony; 4th rate.  
 Timber, pine and fir.  
 Mountainous or heavily timbered land, 60.60 chs.  
 August 22, 1890.  
 NOTE.—The sky was overcast during the entire night. Polaris not visible.

August 23, 1890.  
 N. 89° 59' E. on the secant, through sec. 33.  
 8.10 Over stony ground on top of ridge.  
 Begin descent over rocky ground, sloping S. E.  
 Difference between measurements of 40.00 chs., by two sets of chainmen, is 18 lks.; position of middle point  
 By 1st set, 39.91 chs.  
 By 2nd set, 40.09 chs.; the mean of which is  
 40.00 S. 2.55 ft. from secant,  
 Set a granite stone, 19 x 8 x 7 ins., 14 ins. in the ground, for standard 1/4 sec. cor., marked S. C. 1/4 on N. face; and raise a mound of stone, 2 ft. base, 1 1/2 ft. high, N. of cor. Pits impracticable.  
 This cor. is 40 ft. below top of ridge.  
 76.30 Enter scattering, stunted cedars, bearing N. and S.  
 Difference between measurements of 80.00 chs., by two sets of chainmen, is 16 lks.; position of middle point  
 By 1st set, 80.08 chs.  
 By 2nd set, 79.92 chs.; the mean of which is  
 80.00 S. 2.72 ft. from the secant,  
 Set a granite stone, 19 x 8 x 6 ins., 15 ins. in the ground, for standard cor. of secs. 33 and 34, marked S. C. on N., with 3 grooves on E. and W. faces; from which  
 A cedar, 6 ins. diam., bears N. 22 1/2° E., 32 lks. dist., marked T. 13 N., R. 21 E., S. 34, B. T.  
 A cedar, 8 ins. diam., bears N. 41 1/4° W., 45 lks. dist., marked T. 13 N., R. 21 E., S. 33, B. T.

-144-

*Third Standard Parallel North, through Range 21 East—Continued.*

Chains.	
	This cor. is 100 ft. below top of ridge. Land, mountainous. Soil, rocky; 4th rate. Timber, scattering cedars. Mountainous land, 80.00 chs.
16.10	East, on the secant, through sec. 34. Descend eastern slope through scattering cedars. Begin very steep descent to Black River Canon, bears N. E. and S. W.
20.00	Foot of descent, 300 ft. below last cor., bears N. E. and S. W.
20.68	To right bank of Black River, course S. 28° W. S. 2.64 ft. <sup>74</sup> from the secant, Set a granite stone 19 x 8 x 5 ins., 15 ins. in the ground, for meander cor. on S. bdy. sec. 34, marked S. C. on N., and M. C. on E. faces; dig a pit, 3 ft. sq., 8 ft. W., of stone; and raise a mound of earth, 4 ft. base, 2 feet high, W. of cor. To find the distance across the river, I set a flag on the secant line, on east bank; then measure a base, N. 6.20 chs., to a point from which the flag bears S. 43° 10'

E.; which gives for the distance, tan. 43° 10' x base, or 0.938 x 6.20 chs. = 5.82 chs.  
 26.50 To left bank of Black River, course S. W. Banks, 12 ft. high; rapid current over stony bottom; clear water, about 5 ft. deep:  
 S. 2.64 ft.<sup>74</sup> from the secant,  
 Set a granite stone, 17 x 9 x 7 ins., 12 ins. in the ground, for meander cor. on S. bdy. sec. 34, marked S. C. on N., and  
 M. C. on W. faces; dig a pit, 3 ft. sq., 8 ft. E. of stone; and raise a mound of earth, 4 ft base, 2 ft. high, E. of cor.  
 Thence, up steep ascent through scattering cedars.  
 Difference between the measurements of 40.00 chs., by the two sets of chainmen, is 20 lks.; position of middle point  
 By 1st set, 39.90 chs.  
 By 2nd set, 40.10 chs.; the mean of which is  
 S. 2.55 ft. from the secant:  
 A cedar, 7 ins. diam., for standard 1/4 sec. cor., I mark S. C., 1/4 S. on N. side; from which  
 A cedar, 4 ins. diam., bears N. 31° E., 20 lks. dist., marked S. C., 1/4 S., B. T.  
 A cedar, 6 ins. diam., bears N. 64 1/4° W., 18 lks. dist., marked S. C., 1/4 S., B. T.  
 Thence up side of ridge, sloping S. W.  
 40.40 Leave scattering cedars, bearing N. E. and S. W.  
 Difference between measurements of 80.00 chs., by two sets of chainmen, is 18 lks.; position of middle point  
 By 1st set, 80.09 chs.  
 By 2nd set, 79.90 chs.; the mean of which is  
 80.00 S. 2.04 ft. from the secant,  
 Set a granite stone, 21 x 8 x 5 ins., 16 ins. in the ground, for standard cor. of secs. 34 and 35, marked S. C. on N., with 2 grooves on . and 4 grooves on W. faces; and raise a mound of stone, 2 ft. base, 1 1/2 ft. high, N. of cor. Pits impracticable.  
 This cor. is on top of a ridge, about 300 ft. above Black River.  
 Land, mountainous.  
 Soil, rocky; 4th rate.  
 Timber, scattering cedars.  
 Mountainous land, 80.00 chs.  
 August 23, 1890.

NOTE.—Continuous rain since afternoon of August 23; observations on Polaris not possible.  
 August 25, 1890, 7 a. m.  
 S. 89° 59' E. on the secant, through sec. 35.

-145-

*Third Standard Parallel North, through Range 21 East—Continued.*

Chains.	
40.00	Descend over rough, stony ground sloping S. Difference between measurements of 40.00 chs., by two sets of chainmen, is 14 lks.; position of middle point By 1st set, 40.07 chs. By 2nd set, 39.93 chs.; the mean of which is S. 1.19 ft. from the secant, Set a granite stone, 15 x 8 x 5 ins., 10 ins. in the ground, for standard 1/4 sec. cor., marked S. C. 1/4 on N. face; dig pits, 18 x 18 x 12 ins., E. and W. of stone, 3 ft. dist.; and raise a mound of earth 3 1/2 ft. base, 1 1/2 ft. high, N. of cor. This cor. is about 280 ft. below top of ridge. Descend abruptly, 90 ft.
50.10	Bottom of ravine, 10 lks. wide, course S. 20° W.; water in holes; thence, steep ascent over ground sloping W.

74. These distances may be found by taking the mean of the offsets at the preceding sec., and following 1/4 sec. cor.

56.40 Enter pine timber, bears N. E. and S. W.  
 56.58 A pine, 16 ins. diam., on line, I mark with 2 notches on E. and W. sides.  
 68.40 Leave pine timber, bears N. E. and S. W.  
 68.50 Alexander Selkirk's house, bears S., 8.40 chs. dist.  
 73.50 Road, bears N. and S.  
 Difference between measurements of 80.00 chs., by two sets of chainmen, is 16 lks.; position of middle point  
 By 1st set, 79.92 chs.  
 By 2nd set, 80.08 chs.; the mean of which is  
 80.00 <sup>75</sup>Set a limestone, 20 x 8 x 6 ins., 15 ins. in the ground, for standard cor. of secs. 35 and 36, marked S. C. on N., with 1 groove on E. and 5 grooves on W. faces; dig pits, 24 x 18 x 12 ins., crosswise on each line, E. and W., 3 ft., and N. of stone, 7 ft. dist.; and raise a mound of earth, 4 ft. base, 2 ft. high, N. of cor. This cor. is about 60 ft. above ravine.  
 Land, mountainous.  
 Soil, stony; 4th rate.  
 Timber, pine.  
 Mountainous land, 80.00 chs.

---

S. 89° 58' E. on the secant, S. of sec. 36.  
 Ascend over ground sloping W.  
 12.70 Enter heavy oak timber, bears N. and S.  
 28.30 Top of ridge, 80 ft. above last cor., bears N. and S.  
 38.50 Leave heavy oak timber, bears N. and S.  
 Difference between measurements of 40.00 chs., by two sets of chainmen is 14 lks.; position of middle point  
 By 1st set, 40.07 chs.  
 By 2nd set, 39.93 chs.; the mean of which is  
 40.00 N. 1.53 ft. from the secant,  
 Set a limestone, 16 x 7 x 5 ins., 11 ins. in the ground, for standard ¼ sec. cor., marked S. C. ¼ on N. face; dig pits, 18 x 18 x 12 ins., E. and W. of stone, 3 ft. dist.; and raise a mound of earth, 3½ ft. base, 1½ ft. high, N. of cor.  
 52.20 Road, bears N. 70° E. and S. 60° W.  
 68.10 Creek, 20 lks. wide, course S. 50° W.; ascend over ground sloping W., about 90 ft.  
 Difference between measurements of 80.00 chs., by two sets of chainmen, is 18 lks.; position of middle point  
 By 1st set, 79.91 chs.  
 By second set, 80.09 chs.; the mean of which is  
 80.00 N. 3.39 ft. from the secant,  
 Set a granite stone, 20 x 7 x 67 ins., 15 ins. in the ground for standard cor. of Tps. 13 N., Rs. 21 and 22 E., marked<sup>76</sup>  
 S. C., 13 N. on N.,  
 22 E. on E., and  
 21 E. on W. faces; with 6 grooves on N. E., and W. faces; dig pits, 30 x 24 x 12 ins., crosswise on each line, E. and W., 4 ft.; and N. of stone, 8 ft. dist.; and raise a mound of earth, 5 ft. base, 2½ ft. high, N. of cor.  
 Land, mountainous.

(Pages 146 through 160 deleted. They contain field notes and final oaths for the survey of the Third Standard Parallel North, through Ranges 22, 23 and 24 East by Secant, Tangent offset and Solar transit methods. The vein and style of notes are the same.)

75. The secant intersects the standard parallel 1 mile from end of secant, and at the point for the corner of secs. 35 and 36. See Plat II, figs. 1 and 2.

76. See "STANDARD TOWNSHIP CORNERS," page 23.

## SPECIMEN FIELD NOTES.

No. 2.

TITLE PAGE.

(See Plate III.)

FIELD NOTES

## OF THE SURVEY OF THE SIXTH GUIDE MERIDIAN EAST

THROUGH

Townships No. 13 North  
Between Ranges Nos. 24 and 25 East

OF THE

PRINCIPAL BASE AND MERIDIAN

IN THE

STATE OF MONTANA,

AS SURVEYED BY

RICHARD ROODS,

U. S. DEPUTY SURVEYOR,  
UNDER HIS CONTRACT No. 97,  
DATED JULY 10, 1890.

*Survey commenced August 29, 1890.*

*Survey completed August 30, 1890.*

-161-

(Pages 162 and 163 deleted. They contain the sample index and the preliminary oaths of assistants.)

-164-

6th Guide Meridian East, through Tps. 13 N., between Rs. 24 and 25 E.

Chains.	Survey commenced August 29, 1890, and executed with a W. & L. E. Gurley light mountain transit, No. _____, the horizontal limb being provided with two opposite verniers reading to 30" of arc. I begin at the Standard Corner of Township 13 North, Ranges 24 and 25 East, which I established August 29, 1890. <sup>77</sup> Latitude 45° 34'.5 N., longitude 107° 24' W.
---------	--

77. See footnote, page 154.

6th Guide Meridian East, through Tps. 13 N., etc.—  
Continued.

At this corner, at 8<sup>h</sup> 54<sup>m</sup> p. m., by my watch, which is 3<sup>m</sup> 49<sup>s</sup> fast of local mean time, I observe Polaris at eastern elongation in accordance with instructions in the manual,<sup>79</sup> and mark the point in the line thus determined by a tack driven in a wooden plug set in the ground, 5.00 chs. north of my station.

August 29, 1890.

August 30: At 6<sup>h</sup> 30<sup>m</sup> a. m., I lay off the azimuth of Polaris, 1° 49' .5 to the west, and mark the TRUE MERIDIAN thus determined by a cross on a stone firmly set in the ground, west of the point established last night.  
The magnetic bearing<sup>78</sup> of the true meridian is N. 18° 05' W., which reduced by the table on page 100 of the Manual gives the mean mag. decl. 18° 02' E.  
From the standard cor. I run  
North, bet. Secs. 31 and 36.  
Descend over ground sloping N. W.  
2.60 Creek 10 lks. wide in ravine, 45 ft. below the Tp. cor., course N. 32° W.  
7.50 To edge of table land, bears N. E. and S. W.; thence over level land.  
17.40 Bluff bank, bears N. 58° W. and S. 58° E.; descend abruptly 40 ft.  
19.00 Bottom of ravine, course S. 58° E.; ascend 50 feet to  
22.00 Edge of table land, bears S. 58° E. and N. 58° W.; thence over level land.  
Difference between measurements of 40.00 chs., by two sets of chainmen, is 18 lks.; position of middle point  
By 1st set, 40.09 chs.  
By 2nd set, 39.91 chs.; the mean of which is  
40.00 Set a limestone 16 x 7 x 5 ins., 11 ins. in the ground, for ¼ sec. cor., marked ¼ on W. face, and raise a mound of stone, 2 ft. base, 1½ ft. high, W. of cor.  
42.60 Stream, 6 lks. wide, in ravine 15 ft. deep, course N. 60° W.  
47.00 Enter heavy oak timber, bears E. and W.  
53.00 An oak, 30 ins. diam., on line, I mark with 2 notches on E. and W. sides.  
55.20 Creek, 20 lks. wide, 1 ft. deep, course N. 83° W.  
55.40 Right bank of creek, begin very steep rocky ascent.  
60.00 Top of ridge, 250 ft. above creek, bears N. 80° W. and S. 80° E.  
64.00 Begin descent.  
Difference bet. measurements of 80.00 chs., by two chainmen, is 22 lks.; position of middle point  
By 1st set, 79.89 chs.  
By 2nd set, 80.11 chs.; the mean of which is  
80.00 The point for sec. cor., 150 ft. below top of ridge, falls on a flat rock in place, 10 ft. E. and W. by 6 ft. N. and S., on which I  
Cut a cross (x) at the exact cor. point, for cor. of secs. 25, 30, 31, and 36, marked with 5 grooves on N and 1 groove on S. sides; from which  
An oak, 10 ins. diam., bears N. 22° E., 54 lks. dist., marked T. 13 N., R. 25 E., S. 30, B. T.  
A dogwood, 5 ins. diam., bears S. 64½° E., 40 lks. dist., marked T. 13 N., R. 25 E., S. 31, B. T.  
An ash, 13 ins. diam., bears S. 51° W., 37 links dist., marked T. 13 N., R. 34 E., S. 36, B. T.  
An oak, 9 ins. in diam., bears N. 34° W., 42 lks. dist., marked T. 13 N., R. 24 E., S. 25, B. T.  
Land, level and mountainous.  
Soil, Gravel and rock; 4th rate.  
Timber, oak.  
Mountainous or heavily-timbered land, 33.00 chs.

Chains.	North, bet. secs. 25 and 30.
	Descend through heavy oak timber.
2.00	Precipitous descent of 60 ft., down which I can not chain; set a flag on line at foot of precipice; measure a base east 4 chs. to a point, from which the flag bears N. 68° W.; which gives for the distance (by traverse table) 1.50 chs., which, added to 2.00 chs., makes
3.50	To foot of precipice, bears E. and W.; thence, descend.
8.50	Leave heavy oak timber, bears E. and W.
13.00	Begin abrupt descent.
17.10	To creek, 10 lks. wide, pure water, course N. 70° W.; 240 ft. below top of ridge. Ascend 20 ft. to
20.90	Edge of level plain, bears N. 80° W. and S. 80° E.
	Difference bet. measurements of 40.00 chs., by two sets of chainmen, is 20 lks.; position of middle point By 1st set, 39.90 chs. By 2nd set, 40.10 chs.; the mean of which is
40.00	Set a cedar post, 3 ft. long, 3 ins. sq., with marked stone, 24 ins. in the ground, for ¼ sec. cor., marked ¼ S., on W. face; dig pits, 18 x 18 x 12 ins., N. and S. of post, 3 ft. dist.; and raise a mound of earth, 3½ ft. base, 1½ ft. high, W. of cor. Diff. between measurements of 80.00 chs., by two sets of chainmen, is 6 lks.; position of middle point By 1st set, 80.03 chs. By 2nd set, 79.97 chs.; the mean of which is
80.00	Set a cedar post, 3 ft. long, 4 ins. sq., with marked stone, 24 ins. in the ground, for cor. of secs. 19, 24, 25, and 30, marked T. 13 N., S. 19 on N. E. R. 25 E., S. 30 on S. E. S. 25 on S. W., and R. 24 E., S. 24 on N. W. faces; with 4 notches on N. and 2 notches on S. edges; dig pits, 18 x 18 x 12 ins., in each sec., 5½ ft. dist.; and raise a mound of earth, 4 ft. base, 2 ft. high, W. of cor. Land, mountainous and level. Soil, stony and sandy; 4th rate. Timber, oak. Mountainous or heavily-timbered land, 20.90 chs.
	North, bet. secs. 19 and 24.
	Over descending ground.
35.00	Ravine, 20 ft. wide, 8 ft. deep, course E. Difference between measurements of 40.00 chs., by two sets of chainmen, is 6 lks.; position of middle point By 1st set, 39.97 chs. By 2nd set, 40.03 chs.; the mean of which is
40.00	Set a cedar post, 3 ft. long, 3 ins. sq., with marked stone, 24 ins. in the ground, for ¼ sec. cor., marked ¼ S., on W. face; dig pits, 18 x 18 x 12 ins., N. and S. of post, 3 ft. dist.; and raise a mound of earth, 3½ ft. base, 1½ ft. high, W. of cor.
40.30	Enter willow brush, bears E. and W.
44.00	Leave willow brush, bears E. and W.; Ford's Creek, 22 lks. wide; banks, 3 ft. high; pure water, gentle current; course E.
48.50	Ford's Creek, 24 lks. wide, course W.
55.00	Ford's Creek, 26 lks. wide, course N. 70° E.
61.70	Ravine, 15 ft. wide, 6 ft. deep, course E. Difference between measurements of 80.00 chs., by two sets of chainmen, is 12 lks.; position of middle point By 1st set, 80.06 chs. By 2nd set, 79.94 chs.; the mean of which is
80.00	Deposit a quart of charcoal, 12 ins. in the ground, for cor. of secs. 13, 18, 19, and 24; dig pits, 18 x 18 x 12 ins., in each sec., 4 ft. dist.; and raise a mound of

78. See footnote, page 106.

earth, 4 ft. base, 2 ft. high, over deposit.  
 In S. E. pit drive a stake, 2 ft. long, 2 ins. sq.,  
 12 ins. in the ground, marked  
 T. 13 N., S. 18 on N. E.,  
 R. 25 E., S. 19 on S. E.,  
 S. 24 on S. W., and  
 R. 24 E., S. 13 on N. W. faces; with 3 notches on  
 N. and S. edges.

-166-

6th Guide Meridian East, through Tps. 13 N., etc.—  
 Continued.

Chains.	Land, nearly all level. Soil, sandy loam and clay; 1st stand 4th rate. No timber.
	North, bet. secs. 13 and 18. Over nearly level plain; gradually ascend.
29.00	Begin ascent to ridge, bears E. and W.
34.10	Top of ridge, 60 ft. above plain, bears E. and W.
35.20	Begin descent from ridge.
37.50	Foot of descent; branch, 10 lks. wide in ravine 5 ft. deep; course E. ascend.
	Difference between measurements of 40.00 chs., by two sets of chainmen, is 16 lks.; position of middle point By 1st set, 39.92 chs. By 2nd set, 40.08 chs.; the mean of which is
40.00	Set a granite stone, 15 x 8 x 5 ins., 10 ins. in the ground, for ¼ sec. cor., marked ¼ on W. face; and raise a mound of stone, 2 ft. base, 1½ ft. high, W. of cor. Pits impracticable.
47.00	Begin ascent of ridge, bears E. and W.
56.50	Top of ridge, 400 ft. above plain, bears E. and W.
63.00	Begin descent. Difference between measurements of 80.00 chs., by two sets of chainmen, is 22 lks.; position of middle point By 1st set, 80.11 chs. By 2nd set, 79.89 chs.; the mean of which is
80.00	Set a granite stone, 15 x 8 x 6 ins., 10 ins. in the ground, for cor. of secs. 7, 12, 13, and 18, marked with 2 notches on N. and 4 notches on S. edges; and raise a mound of stone, 2 ft. base, 1½ ft. high, W. of cor. Pits impracticable. This cor. stands on a bench, about 350 ft. below top of ridge. Land, level and mountainous. Soil, sandy loam and rocky; 2nd and 4th rate. No timber. Mountainous land, 11.50 chs.
	North, bet. secs. 7 and 12. Over level land.
2.00	Begin ascent, bears E. and W.
7.50	Top of low ridge, 20 ft. above sec. cor., bears E. and W.; thence, descend gradually.
37.00	Branch, 6 lks. wide, in ravine, 10 ft. deep, course E. Difference between measurements of 40.00 chs., by two sets of chainmen, is 12 lks.; position of middle point By 1st set, 39.94 chs. By 2nd set, 40.06 chs.; the mean of which is
40.00	Set a cedar post, 3 ft. long, 3 ins. sq., with a marked stone, 24 ins. in the ground, for ¼ sec. cor., marked ¼ S. on W. face; dig pits, 18 x 18 x 12 ins., N. and S. of post, 3 ft. dist.; and raise a mound of earth, 3½ ft. base, 1½ ft. high, W. of cor.
	Thence over plain gradually ascending.
71.00	Begin descent to creek, bears E. and W.
74.00	Foot of descent; creek, 12 lks. wide, course E. Ascend.
79.50	To top of ascent and edge of level plain, bears E. and N. 75° W. Difference between measurements of 80.00 chs., by two sets

of chainmen, is 14 lks.; position of middle point  
 By 1st set, 80.07 chs.  
 By 2nd set, 79.93 chs.; the mean of which is  
 Set a cedar post, 3 ft. long, 11 ins. sq., with marked stone, 24 ins. in the ground, for cor. of secs. 7, 12, 13, and 18, marked  
 T. 13 N., S. 6 on N. E.,  
 R. 25 E., S. 7 on S. E.,  
 S. 12 on S. W., and  
 R. 24 E., S. 1 on N. W. faces; with 1 notch on N. and 5 notches on S. edges; dig pits, 18 x 18 x 12 ins., in each sec., 5½ ft. dist.; and raise a mound of earth, 4 ft. base, 2 ft. high, W. of cor.

-167-

6th Guide Meridian East, through Tps. 13 N., etc.—  
 Concluded.

Chains.	Land, nearly level. Soil, sandy loam; 2nd rate. No timber.
	North, bet. secs. 1 and 6. Over level land.
18.00	Branch 4 lks. wide, in ravine 6 ft. deep, course E. Difference between measurements of 40.00 chs., by two sets of chainmen, is 6 lks.; position of middle point By 1st set, 39.97 chs. By 2nd set, 40.03 chs; the mean of which is
40.00	Deposit a marked stone, 12 ins. in the ground, for ¼ sec. cor., dig pits, 18 x 18 x 12 ins., N. and S. of cor., 4 ft. dist.; and raise a mound of earth, 3½ ft. base, 1½ ft. high, over deposit. In S. pit drive a cedar stake, 2 ft. long, 2 ins. sq., 12 ins. in the ground, marked ¼ S. on W. face.
61.00	Creek, 12 lks. wide, course S. 23° E. Difference between measurements of 80.00 chs., by two sets of chainmen, is 4 lks.; position of middle point By 1st set, 80.02 chs. By 2nd set, 79.98 chs.; the mean of which is
80.00	Set a cedar post, 3 ft. long, 4 ins. sq., with quart of charcoal, 24 ins. in the ground, for cor. of Tps. 13 and 14 N., Rs. 24 and 25 E., marked T. 14 N., S. 31 on N. E., R. 25 E., S. 6 on S. E., T. 13 N., S. 1 on S. W., and R. 24 E., S. 36 on N. W. faces; with 6 notches on each edge; dig pits, N., E., and W., 4 ft. and S. of post, 8 ft. dist.; and raise a mound of earth, 5 ft. base, 2½ ft. high, S. of cor. Land, level. Soil, sandy loam; 1st rate. No timber.

August 30, 1890.

GENERAL DESCRIPTION.

Townships 13 N., Ranges 24 and 25 East, are generally rolling table-lands, producing an abundant growth of grass, and there is some good land along Ford's Creek and its tributaries. About two miles east of the corner of Tps. 13 and 14 N., Rs. 24 and 25 E., is a lake some two and half miles long by two miles wide, lying in Tps. 13 and 14 N., R. 25 E.

RICHARD ROODS,  
 U. S. Deputy Surveyor.

AUGUST 30, 1890.

(Page 168 deleted. Contains final oaths.)

**SPECIMEN FIELD NOTES.**

**No. 3.**

**TITLE PAGE.**

[See Plate III.]

**FIELD NOTES**

**OF THE SURVEY OF THE  
EAST AND NORTH BOUNDARIES**

**OF**

**TOWNSHIP NO. 13 NORTH, RANGE NO. 21 EAST**

**OF THE**

**PRINCIPAL BASE AND MERIDIAN**

**IN THE**

**STATE OF MONTANA,**

**AS SURVEYED BY**

**RICHARD ROODS,**

**U. S. DEPUTY SURVEYOR,**

**UNDER HIS CONTRACT No. 97,  
DATED JULY 10, 1890.**

*Survey commenced September 8, 1890.*

*Survey completed September 13, 1890.*

-169-

*(Pages 170 and 171 deleted. They contain the sample index and preliminary oaths of assistants.)*

-172-

*East boundary of T. 13 N., R. 21 E.*

Chains.	Survey commenced September 8, 1890, and executed with a Young & Sons light mountain transit, No. _____, with solar attachment. The horizontal limb is provided with two double verniers placed opposite to each other, reading to single minutes of arc, which is also the least count of the verniers of the latitude and declination arcs. The instrument was examined, tested on the true meridian at Helena, found correct, and was approved by the surveyor general for Montana, September 1, 1890. I examine the adjustments of the transit, and correct the
---------	--

level and collimation errors; then, to test the solar apparatus by comparing its indications, resulting from solar observations made during a. m. and p. m. hours, with a true meridian determined by observations on Polaris, I proceed as follows:

September 8: At the standard corner of Tps. 13 N., Rs. 21 and 22° E., latitude 45° 34' .5 N., longitude 107° 46' W., at 4<sup>h</sup> 57<sup>m</sup> p. m., l. m. t., I set off 45° 35' on the lat. arc; 5° 29' N. on the decl. arc (these settings being the nearest practicable to the true minutes and fractions thereof required); determine with the solar a true meridian; and mark a point thereof on a stone set firmly in the ground, 5.00 chs. N. of the cor. At 8<sup>h</sup> 15<sup>m</sup> .5 p. m., by my watch, which is 4<sup>m</sup> 23<sup>s</sup> fast of l. m. t., I observe Polaris at eastern elongation, in accordance with Manual of Instructions,<sup>39</sup> and mark a point on the line thus determined on a plug driven in the ground, 5.00 chs. N. of my station.

September 8, 1890.

September 9: at 6<sup>h</sup> 30<sup>m</sup> a. m., l. m. t., I lay off the azimuth of Polaris, 1° 49' .6, to the west and mark the TRUE MERIDIAN thus determined, by cutting a small groove in the stone set September 8, on which the true meridian falls 0.25 ins. west of the mark determined by the solar.

At 6<sup>h</sup> 58<sup>m</sup> a. m., l. m. t., I set off 45° 35' on the lat. arc; 5° 15' N., on the decl. arc; and mark a point in the true meridian determined with the solar, by a cross on the stone already set 5.00 chs. N. of my station; this mark falls 0.3 ins. west of the true meridian established by the Polaris observation.

The solar apparatus, by p. m. and a. m. observations, defines positions for true meridians, respectively about 0' 13" east and 0' 16" west of the true meridian established by the Polaris observations; therefore, I conclude the adjustments of the instrument are satisfactory

The magnetic bearing of the true meridian,<sup>79</sup> at 7 a. m., is N. 18° 10' W.; the angle thus determined, reduced by the table, page 100, gives the mean mag. decl. 18° 07' E.

I begin at the standard corner of Tps. 13 N., Rs. 21 and 22 E., which I established August 25, 1890.

Thence I run

North, bet. secs. 31 and 36.

Descend abruptly over stony ground, sloping N. W. Creek, 80 ft. below Tp. cor., 15 lks. wide, clear water, course S. 75° W.; ascend.

Road, bears N. 60° E. and S. 60° W.

Top of ridge, 200 ft. above creek, bears E. and W.

Begin descent.

Foot of descent, 150 ft. below top of ridge, bears E. and W. Branch 2 lks. wide, clear water, course E. Thence over level land.

Begin descent.

Foot of descent, 30 ft. below bench, bears E. and W.; thence thence over level land.

Set a sandstone, 15 x 8 x 6 ins., 10 ins. in the ground, for ¼ sec. cor., marked ¼ on W. face; dig pits, 18 x 18 x 12 ins., N. and S. of stone, 3 ft. dist.; and raise a mound of earth, 3½ ft. base, 1½ ft. high, W. of cor.

Creek 10 lks. wide, pure water, 8 ins. deep, course E. Begin ascent.

Top of ridge, bears N. 70° E. and N. 80° W., 50 ft. above creek.

Begin descent.

79. See footnotes, pages 106 and 142.

East boundary of T. 13 N., R. 21 E.—Continued.

Chains.	
54.00	Branch 6 lks. wide, in ravine chs. wide, 30 ft. deep, course E.; thence, over level land.
62.50	Creek 12 lks. wide, 1 ft. deep, pure water, course S. 60° E.
73.00	Enter cedar timber, bears E. and W.
74.79	A cedar, 10 ins. diam., on line, I mark with 2 notches on N. and S. sides.
80.00	A cedar, 8 ins. diam., for cor. of secs. 25, 30, 31, and 36, I mark T. 13 N., S. 30 on N. E., R. 22 E., S. 31 on S. E., S. 36 on S. W., and R. 21 E., S. 25 on N. W. sides; with 5 notches on N. and 1 notch on S. sides; from which A cedar, 7 ins. diam., bears N. 30½° E., 20 lks. dist., marked T. 13 N., R. 22 E., S. 30, B. T. A cedar, 6 ins. diam., bears S. 63¼° E., 18 lks. dist., marked T. 13 N., R. 22 E., S. 31, B. T. A cedar, 9 ins. diam., bears S. 23¼° W., 21 lks. dist., marked T. 13 N., R. 21 E., S. 36, B. T. A cedar, 8 ins. diam., bears N. 64½° W., 19 lks. dist., marked T. 13 N., R. 21 E., S. 25, B. T. Land, mountainous and level. Soil, stony and loam; 2nd and 4th rate. Timber, cedar. Mountainous land, 54.00 chs.
	North, bet. secs. 25 and 30. Over level land, through cedar timber.
9.00	Creek 13 lks. wide, pure water, 1 ft. deep, gentle current, course S. 80° E.
20.40	Creek 15 lks. wide, pure water, 2 ft. deep, gentle current, course S. 70° E.
27.50	Leave cedar timber, begin ascent, bears S. 70° E. and N. 70° W.
39.50	Top of ascent of 40 ft., enter level plain, bears E. and W.
40.00	Set a cedar post, 3 ft. long, 3 ins. sq., with charred stake, 24 ins. in the ground, for ¼ sec. cor., marked ¼ S. on W. face; dig pits, 18 x 17 x 12 ins., N. and S. of post, 3 ft. dist.; and raise a mound of earth, 3½ ft. base, 1½ ft. high, W. of cor. September 9: At this ¼ sec. cor. I set off 5° 9' N., on the decl. arc; and at 11 <sup>h</sup> 57 <sup>m</sup> . 11. m. t., observe the sun on the meridian; the resulting lat. is 45° 36.0' which is about 0.2' greater than the proper lat.
75.00	Creek 12 lks. wide, pure water, 1 ft. deep, gentle current, course S. 80° E.
80.00	Set a cedar post, 3 ft. long, 4 ins. sq., with quart of charcoal, 24 ins. in the ground, for cor. of secs. 19, 24, 25, and 30; marked T. 13 N., S. 19 on N. E., R. 22 E., S. 30 on S. E., S. 25 on S. W., and R. 21 E., S. 24 on N. W. faces; with 4 notches on N. and 2 notches on S. edges; dig pits, 18 x 18 x 12 ins., in each sec. 5½ ft. dist.; and raise a mound of earth, 4 ft. base, 2 ft. high, W. of cor. Land, level. Soil, sandy loam; 2nd rate. Timber, cedar.
	North, bet. secs. 19 and 24. Over level land.
6.00	Branch 4 lks. wide, course S. 70° E.; ascend.
17.00	Top of ridge, 40 ft. high, bears E. and W.
22.00	Begin descent.
36.50	Foot of descent, bears E. and W.; thence over level land.

40.00	Set a sandstone, 15 x 8 x 6 ins., 10 ins. in the ground, for ¼ sec. cor., marked ¼ on W. face; dig pits, 18 x 18 x 12 ins., N. and S. of stone, 3 ft. dist.; and raise a mound of earth, 3½ ft. base, 1½ ft. high, W. of cor.
47.50	Creek 15 lks. wide, pure water, low banks, course N. 70° W.
64.00	Creek 16 lks. wide, pure water, low banks, course S. 65° E.

-174-

East boundary of T 13 N., R. 21 E.—Concluded.

Chains.	
80.00	Set a cedar post, 3 ft. long, 4 ins. sq., with charred stake, 24 ins. in the ground, for cor. of secs. 13, 18, 19, and 24, marked T. 13 N., S. 18 on N. E., R. 20 E., S. 19 on S. E., S. 24 on S. W., and R. 21, S. 13 on N. W. faces; with 3 notches on N. and S. edges; dig pits, 18 x 18 x 12 ins., in each sec., 5½ ft. dist.; and raise a mound of earth, 4 ft. base, 2 ft. high, W. of cor. Land, level. Soil, sandy loam; 1st rate. No timber. September 9, 1890.
	September 10: At 7 <sup>h</sup> 56.8 <sup>m</sup> a. m., I set off 45° 37' on the lat. arc; 4° 47' N., on the decl. arc; and determine a true meridian with the solar, at the cor. of secs. 13, 18, 19, and 24. Thence I run North, bet. secs. 13 and 18.
40.00	Set a cedar post, 3 ft. long, 3 ins. sq., with marked stone, 24 ins. in the ground, for ¼ sec. cor., marked ¼ S. on W. face; dig pits, 18 x 18 x 12 ins., N. and S. of post, 3 ft. dist; and raise a mound of earth, 3½ ft. base, 1½ ft. high, W. of cor.
80.00	Set a limestone, 20 x 8 x 4 ins., 15 ins. in the ground, for cor. of secs. 7, 12, 13, and 18, marked with 2 notches on N. and 4 notches on S. edges; dig pits, 18 x 18 x 12 ins., in each sec., 5½ ft. dist.; and raise a mound of earth, 4 ft. base, 2 ft. high, W. of cor. Land, level. Soil, sandy loam; 1st rate. No timber.
	North, bet. secs. 7 and 12. Over level land.
40.00	Set a cedar post, 3 ft. long, 3 ins. sq., with quart of charcoal, 24 ins. in the ground, for ¼ sec. cor. marked ¼ S., on W. face; dig pits, 18 x 18 x 12 ins., N. and S. of post, 3 ft. dist.; and raise a mound of earth, 3½ ft. base, 1½ ft. high, W. of cor.
55.00	Creek, 8 lks. wide, in ravine 1 ch. wide, 20 ft. deep, course N. 60° E.
80.00	Set a limestone, 19 x 8 x 6 ins., 15 ins. in the ground, for cor. of secs. 1, 6, 7, and 12, marked with 1 notch on N. and 5 notches on S. edges; dig pits, 18 x 18 x 12 ins., in each sec., 5½ ft. dist.; and raise a mound of earth, 4 ft. base, 2 ft. high, W. of cor. Land, level. Soil, sandy loam; 1st rate. No timber.
	September 10: At this cor. I set off 4° 44' N. on the decl. arc; and at 11 <sup>h</sup> 56 <sup>m</sup> . 81. m. t., observe the sun on the meridian; the resulting lat. is 45° 39', which is about 0'. 1 more than the proper lat.
	North, bet. secs. 1 and 6.
32.50	Creek, 15 lks. wide, impure water, sluggish current, low muddy banks, course E.

40.00	Set a locust post, 3 ft. long, 3 ins. sq., with quart of charcoal, 24 ins. in the ground, for ¼ sec. cor., marked ¼ S., on W. face; dig pits, 18 x 18 x 12 ins., N. and S. of post, 3 ft. dist.; and raise a mound of earth, 3 ½ ft. base, 1 ½ ft. high, W. of cor.	September 10, 1890.
80.00	Set a limestone, 15 x 8 x 7 ins., 10 ins. in the ground, for cor. of Tps. 13 and 14 N., Rs. 21 and 22 E., marked with 6 notches on each edge; dig pits, 24 x 24 x 12 ins., on each line, N., E., and W.; 4 ft., and S. of stone, 8 ft. dist., and raise a mound of earth, 5 ft. base, 2 ½ ft. high, S. of cor.	

-175-

*North boundary of T. 13 N., R. 21 E.*

Chains.	September 11: At 7 <sup>h</sup> 56.4 <sup>m</sup> a. m., 1. m. t. I set off 45° 40' on the lat. arc; 4° 25' N., on the decl. arc; and determine a true meridian with the solar, at the cor. of Tps. 13 and 14 N., Rs. 21 and 22 E. Thence I run West on a random line, along the N. bdy. of Tp 13 N., R. 21 E., setting temp. ¼ sec. and sec. cors. at intervals of 40.00 chs.; and, at 479.25 chs., intersect the 5th Guide Meridian, 42 lks. N. of the cor. of Tps. 13 and 14 N., Rs. 20 and 21 E., which is a limestone, 5 x 8 x 6 ins. above ground, marked and witnessed as described by the surveyor general. The falling answers to a correction of 0° 03', or 7 lks. S. per mile. counting from the N. E. cor. of the Tp.; therefore I run N. 89° 57' E., bet. secs. 6 and 31. Over level land.	
39.25	Set a cedar post, 3 ft. long, 3 ins. sq., with marked stone, 24 ins. in the ground, for ¼ sec. cor., marked ¼ S., on N. face; dig pits, 18 x 18 x 12 ins., E. and W. of post, 3 ft. dist.; and raise a mound of earth, 3 ½ ft. base, 1 ½ ft. high, N. of cor.	
79.25	Set a limestone, 20 x 8 x 4 ins., 15 ins. in the ground, for cor. of secs. 5, 6, 31, and 32, marked with 5 notches on E. and 1 notch on W. edges; dig pits 18 x 18 x 2 ins., in each sec., 5 ½ ft. dist.; and raise a mound of earth, 4 ft. base, 2 ft. high, W. of cor. Land, level. Soil, sandy loam; 1st rate. No timber.	September 11, 1890.
	September 12: At _____ <sup>h</sup> _____ <sup>m</sup> a. m., 1. m. t.; I set off 45° 40' on the lat. arc; 4° 02' N., on the decl. arc; and determine a true meridian with the solar, at the cor. of secs. 5, 6, 31, and 32. Thence I run N. 89° 57' E., bet. secs. 5 and 32.	
40.00	Set a juniper post, 3 ft. long, 3 ins. sq., with quart of charcoal, 24 ins. in the ground, for ¼ sec. cor., marked ¼ S., on N. face; dig pits, 18 x 18 x 12 ins., E. and W. of post, 3 ft. dist.; and raise a mound of earth, 3 ½ ft. base, 1 ½ ft. high, N. of cor.	
47.00	Creek 15 lks. wide, good water, sluggish current, course S. E.	
80.00	Deposit a quart of charcoal, 12 ins. in the ground, for cor. of secs. 4, 5, 32, and 33; dig pits, 18 x 18 x 12 ins., in each sec., 4 ft. dist.; and raise a mound of earth, 4 ft. base, 2 ft. high, over deposit. In S. E. pit drive a cedar stake, 2 ft. long, 2 ins. sq., 12 ins. in the ground, marked T. 14 N., S. 33 on N. E., R. 21 E., S. 4 on S. E., T. 13 N., S. 5 on S. W., and	

S. 32 on N. W. faces; with 4 notches on E. and 2 notches on W. edges.

Land, level.

Soil, sandy loam; 1st rate.

No timber.

September 12: At this cor., I set off 4° 53' N., on the decl. arc; and, at 11<sup>h</sup> 5<sup>m</sup>. 1, 1. m. t., observe the sun on the meridian; the resulting lat. is 45° 40', which is about 0' .3 greater than the proper lat.

September 12, 1890.

N. 89° 57' E., bet. secs. 4 and 33.

7.00 Branch, 4 lks. wide, course S. 35° W.

40.00 Set a limestone, 15 x 8 x 5 ins., 10 ins. in the ground, for ¼ sec. cor. marked ¼ on N. face; dig pits, 18 x 18 x 12 ins., E. and W., of stone, 3 ft. dist.; and raise a mound of earth, 3 ½ ft. base, 1 ½ ft. high, N. of cor.

55.00 Enter heavy oak timber, bears N. and S.

57.13 An oak, 38 ins. diam., on line, I mark with 2 notches on E. and W. sides.

68.00 Branch, 3 lks. wide, course N. 30° E.

-176

*North boundary of T. 13 N., R. 21 E.—Continued.*

Chains.	
80.00	An oak, 14 ins. diam., for cor. of secs. 3, 4, 33, and 34, I mark T. 14 N., S. 34 N. E., R. 21 E., S. 3 on S. E., T. 13 N., S. 4 on S. W., and S. 33 on N. W. sides; with 3 notches on E. and W. sides; from which An oak, 12 ins. diam., bears N. 13 ½° E., 21 lks. dist., marked T. 14 N., R. 21 E., S. 34 B. T. An oak, 14 ins. diam., bears S. 78 ¼° E., 25 lks. dist., marked T. 13 N., R. 21 E., S. 3, B. T. An ash, 10 ins. diam., bears S. 63 ¼° W., 34 lks. dist., marked T. 13 N., R. 21 E., S. 4, B. T. A dogwood, 7 ins. diam., bears N. 26° W., 32 lks. dist., marked T. 14 N., R. 21 E., S. 33, B. T. Land, level. Soil, sandy loam; 1st rate. Timber, oak. Heavily timbered land, 25.00 chs.
	September 13: At _____ <sup>h</sup> _____ <sup>m</sup> , 1. m. t., I set off 45° 40' on the lat. arc; _____° _____' N., on the decl. arc; and determine a true meridian with the solar, at the cor. of secs. 3, 4, 33, and 34. Thence I run N. 89° 57' E., bet. secs. 3 and 34. Over level land, through heavy oak timber. Branch, 4 lks. wide, course S. 10° E.
28.00	An oak, 18 ins. diam., for ¼ sec. cor., I mark ¼ S., on N. side; from which An oak, 14 ins. diam., bears N. 42° E., 27 lks. dist., marked T. 14 N., R. 21 E., S. 34, B. T. An ash, 13 ins. diam., bears S. 48 ¼° E., 25 lks. dist., marked T. 13 N., R. 21 E., S. 3, B. T.
63.00	Leave heavy oak timber, bears N. and S.
80.00	Set a limestone, 22 x 8 x 7 ins., 17 ins. in the ground, for cor. of secs. 2, 3, 34, and 35, marked with 2 notches on E. and 4 notches on W. edges; dig pits, 18 x 18 x 12 ins., in each sec., 5 ½ ft. dist.; and raise a mound of earth, 4 ft. base, 2 ft. high, W. of cor. Land, level. Soil, sandy loam; 1st rate. Timber, oak. Heavily timbered land, 63.00 chs.

	N. 89° 57' E., bet. secs. 2 and 35. Over level land.
30.00	South fork of Spring Creek, 22 lks. wide, pure water, gentle current, low banks, course N. 38° E.
40.00	Set a locust post, 3 ft. long, 3 in. sq., with marked stone, 24 ns. in the ground, for ¼ sec. cor., marked ¼ S. on N. face; dig pits, 18 x 18 x 12 ins., E. and W. of post, 3 ft. dist.; and raise a mound of earth, 3½ ft. base, 1½ ft. high, N. of cor.
80.00	Set a limestone, 15 x 8 x 6 ins., 10 ins. in the ground, for cor. of secs. 1, 2, 35, and 36, marked with 1 notch on E. and 5 notches on W. edges; dig pits, 18 x 18 x 12 ins., in each sec., 5½ ft. dist.; and raise a mound of earth, 4 ft. base, 2 ft. high, W. of cor.
	Land, level. Soil, sandy loam; 1st rate. No timber.
	September 13: At this cor., I set off _____° _____' N., on the decl. arc; and at _____ <sup>h</sup> _____ <sup>m</sup> l. m. t., observe the sun on the meridian; the resulting lat. is 45° 39', which is about 0'.7 less than the proper lat.
	N. 89° 57' E., bet. secs. 1 and 36. Over level land.
40.00	Set a limestone, 18 x 18 x 12 ins., 12 ins. in the ground, for ¼ sec. cor.,

-177-

*North boundary of T. 13 N., R. 21 E.—Concluded.*

Chains.	marked ¼ on N. face; dig pits, 18 x 18 x 12 ins., E. and W. of stone, 3 ft. dist.; and raise a mound of earth, 3½ ft. base, 1½ ft. high, N. of cor.
58.00	Branch 4 lks. wide, course N. 30° E.
70.00	Same branch, 6 lks. wide, course S.
80.00	The cor. of Tps. 13 and 14 N., Rs. 21 and 22 E.
	Land, level. Soil, sandy loam; 1st rate. No timber.
	September 13, 1890.

*Boundaries of T. 13 N., R. 21 E.  
Latitudes, departures, and closing errors.*

Line designated.	True bearing.	Distance.	Latitudes.		Departures.	
			N.	S.	E.	W.
3rd Standard Parallel N.... West.....		Chs. 480.00				480.00
5th G. Meridian E..... North.....		480.00	480.00			
N. bdy. T. 13 N., R. 21 E.... N. 89° 57' E.....		479.25	0.42			479.25
E. bdy. T. 13 N., R. 21 E.... South.....		480.00		480.00		
Convergency <sup>80</sup> .....					0.74	
Totals.....			480.42	480.00	479.99	480.00
			480.00		479.99	
Error in lat.....			0.42	Error in dep.		0.01

This township is rough and mountainous in the southern part, rolling in the interior, and nearly level in the north and east, while prairie land is found in the vicinity of the southwest corner. The township is well watered, and well timbered in the interior; and the soil along the south fork of Spring

80. The convergency will always be entered in the column containing the departure of the north boundary.

Creek and its tributaries is very fertile. The township should be subdivided.

RICHARD ROODS,  
U. S. Deputy Surveyor.

September 13, 1890.

(Remainder of page 177 and all of page 178 deleted. They contain the final oaths.)

-179-

**SPECIMEN FIELD NOTES.—NO. 4.**

*Resurvey of the E. bdy. of T. 25 N., R. 2 W.,  
Willamette Meridian.*

Chains.	(NOTE.—Field notes of retracements and resurveys will be incorporated with the field notes of the subdivisions to which they are directly related, and will be covered by the preliminary and final oaths of said subdivisional field notes. (See page 71.) In case the deputy does not know from recent observations that his instrument is in adjustment, he will make the observations prescribed at the beginning of specimen field notes No. 2, or No. 5, as the character of the instrument employed may require. A transit with solar attachment is the instrument employed for this resurvey.)
	Preliminary to commencing the subdivision of this township, I run north on a blank line, on the east boundary of sec. 36; at 40.00 chs. I find the ¼ sec. cor., N. 80° E., 30 lks. dist., and at 80.00 chs., the cor. of secs. 24, 30, 31 and 36, east, 58 lks. dist.; therefore, I continue my line north, find no part of the E. bdy. in alinement, and that many of the corners are nearly obliterated. At 5 miles 79.83 chs., intersect E. and W. line, 42 lks. E. of the cor. of Tps. 25 and 36 N., Rs. 1 and 2 W., and as these townships have not been subdivided, I resurvey the range line between them, as follows: The old standard cor. of Tps. 25 N., Rs. 1 and 2 W., is a post greatly decayed, and the marks are nearly obliterated. I destroy all traces of the old corner and reestablish it at the same point, as follows: Set a sandstone, 18 x 8 x 5 ins., 12 ins. in the ground, for standard cor. of Tps. 25 N., Rs. 1 and 2 W. marked S. C., on N. face, with 6 grooves on N., E., and W. faces; dig pits, 30 x 24 x 12 ins., crosswise on each line, E. and W., 4 ft., and N. of stone, 8 ft. dist.; and raise a mound of earth, 5 ft. base, 2½ ft. high, N. of cor. Thence I run N. 0° 3' W., bet. secs. 31 and 36. Through timber. Ascend. Top of ridge, about 40 ft. high, bears E. and W. Set a sandstone, 20 x 8 x 4 ins. 15 ins. in the ground, for ¼ sec. cor. marked ¼ on W. face; from which A pine 20 ins. diam., bears N. 20° E., 24 lks. dist. marked ¼ S. B. T. An oak, 16 ins. diam., bears N. 68¼ W., 27 lks. dist., marked ¼ S. B. T. From this point, the old ¼ sec. cor., which is a decayed stake, with marks almost obliterated, bears N. 80° E., 33 lks. dist. I destroy this stake and the marks on the stump of a beech tree, described as a bearing tree in the field notes of the original survey. No trace can be found of a poplar, described as a bearing tree. An oak, 14 ins. diam., on line, I mark with 2 notches on E. and W. sides. Descend.
18.00	
40.00	
52.74	



57.00 Foot of ridge, bears E. and W.; enter rich level land.  
 72.00 Leave timber, bears N. E. and S. W.  
 80.00 Set a cedar post, 3 ft. long, 4 ins. sq., with marked stone, 24 ins. in the ground, for corner of secs. 25, 30, 31, and 36, marked T. 25 N., S. 30 on N. E., R. 1 W., S. 31 on S. E., S. 36 on S. W., and R. 2 W., S. 25 on N. W. faces; with 5 notches on N. and 1 notch on S. edges; dig pits, 18 x 18 x 12 ins. in each sec., 5½ ft. dist.; and raise a mound of earth, 4 ft. base, 2 ft. high, W. of cor. From this cor. the old cor., a decayed post, bears E. 65 lks. I destroy all traces of the old cor. Land, rolling and level. Soil, N. and S. parts, rich loam; 1st rate; middle part, sandy; 2nd rate. Timber, pine and oak.

80.00

earth, 3½ ft. base, 1½ ft. high, W. of cor. I can find no traces of old cor. post, but find slight traces of pits N. 86° E. 46 lks. dist., which I destroy. Set a limestone, 22 x 8 x 4 ins., 17 ins. in the ground, for cor. of secs. 7, 12, 13 and 18, marked with 2 notches on N. and 4 notches on S. edges; dig pits, 18 x 18 x 12 ins., in each sec., 5½ ft. dist.; and raise a mound of earth, 4 ft. base, 2 ft. high, W. of cor. The old cor. which was a post, has disappeared, but indistinct remains of the pits, nearly in their proper places, still remain. The new pits sufficiently obliterate the old ones. Land, gently rolling prairie. Soil, rich loam; 1st rate. No timber. April 12, 1892: I set off 9° 6' N., on the decl. arc; and at 12<sup>h</sup> 0.3<sup>m</sup> p. m., l. m. t., observe the sun on the meridian; the resulting lat., is 47° 35' N.

-180-

*Resurvey of the E. bdy. of T. 25 N., R. 2 W., etc.—Continued.*

Chains.	N. 0° 3' W., bet. secs. 25 and 30. Over level land.
40.00	Set a locust post, 3 ft. long, 3 ins. sq., with quart of charcoal, 24 ins. in the ground, for ¼ sec. cor. marked ¼ S., on W. face; dig pits, 18 x 18 x 12 ins., N. and S. of post, 3 ft. dist.; and raise a mound of earth, 3½ ft. base, 1½ ft. high, W. of cor. All indications of the old cor. have disappeared.
80.00	Set a granite stone, 15 x 8 x 7 ins., 10 ins. in the ground, for cor. of secs. 19, 24, 25 and 30, marked with 4 notches on N. and 2 notches on S. edges; dig pits, 18 x 18 x 12 ins., in each sec., 5½ ft. dit.; and raise a mound of earth, 4 ft. base, 2 ft. high, W. of cor. From this point, the old sec. cor., a post, bears N. 50° E., 41 lks. dist. I destroy the cor. Land, level prairie. Soil, rich loam; 1st rate. No timber.
40.00	N. 0° 3' W., bet. secs. 19 and 24. Over level prairie. Set an oak post, 3 ft. long, 3 ins. sq., with charred stake, 24 ins. in the ground, for ¼ sec. cor., marked ¼ S. on W. face; dig pits, 18 x 18 x 12 ins., N. and S. of post, 3 ft. dist.; and raise a mound of earth, 3½ ft. base, 1½ ft. high, W. of cor. From this point, the old ¼ sec. cor., a decayed post, bears N. 51½° E., 47 lks. dist. I destroy this post, and marks on old bearing trees.
50.00	Elk Creek, 130 lks. wide, shallow at this point, good water, gentle current, course N. W.
80.00	Set a limestone, 18 x 8 x 5 ins., 12 ins. in the ground, for cor. of secs. 13, 18, 19 and 24, marked with 3 notches on N. and S. edges; dig pits, 18 x 18 x 12 ins., in each sec., 5½ ft. dist.; and raise a mound of earth, 4 ft. base, 2 ft. high, W. of cor. After diligent search no signs of the old cor. can be found. Land, level prairie. Soil, rich loam; 1st rate. No timber.
16.50	N. 0° 3' W., bet. secs. 13 and 18. Over prairie land. Coon Creek, 60 lks. wide, 2 ft. deep, good water, course W.
40.00	Set a cedar post, 3 ft. long, 3 ins. sq., with quart of charcoal, 24 ins. in the ground, for ¼ sec. cor. marked ¼ S. on W. face; dig pits, 18 x 18 x 12 ins., N. and S. of post, 3 ft. dist.; and raise a mound of

17.50

N. 0° 3' W., bet. secs. 7 and 12. Over prairie land. Maple Creek, 10 lks. wide; 1 ft. deep, good water, gentle current, course S. W.

-181-

*Resurvey of the E. bdy. of T. 25 N., R. 2 W., etc.—Continued.*

Chains.	Set a cedar post, 3 ft. long, 3 ins. sq., with charred stake, 24 ins. in the ground, for ¼ sec. cor., marked ¼ S. on W. face; dig pits, 18 x 18 x 12 ins., N. and S. of post, 3 ft. dist.; and raise a mound of earth, 3½ ft. base, 1½ ft. high, W. of cor.
40.00	Set a limestone, 20 x 8 x 5 ins., with marked stone, 24 ins. in the ground, for cor. of secs. 1, 6, 7, and 12, marked with 1 notch on N. and 5 notches on S. edges; dig pits 18 x 18 x 12 ins., in each sec., 5½ ft. dist.; and raise a mound of earth, 4 ft. base, 2 ft. high, W. of cor. The old cor. which was a post, has been entirely destroyed by fire, no signs of pits. Land, level prairie. Soil, rich loam; 1st rate. No timber.
80.00	April 12, 1892: A 4 p. m., l. m. t., I set off 47° 36' on the lat. arc; _____° _____', on the decl. arc; and determine a true meridian, at the cor. of secs. 1, 6, 7, and 12. Thence I run N. 0° 3' W., bet. secs. 1 and 6. Over prairie land.
10.40	A spring branch, 3 lks. wide, good water, course S. 70° W.
22.00	Spring of pure water, 3 ft. diam., 2 ft. deep, bears E., 6.00 chs. dist.
40.00	Set a locust post, 3 ft long, 3 ins. sq., with quart of charcoal, 24 ins. in the ground, for ¼ sec. cor., marked ¼ S., on W. face.; dig pits, 18 x 18 x 12 ins., N. and S. of post, 3 ft. dist.; and raise a mound of earth, 3½ ft. base, 1½ ft. high, W. of cor. After diligent search no old ¼ sec. cor. can be found.
46.00	Small branch, 3 lks. wide, sluggish current, course N. W. Enter timber, bears N. W. and S. E.
79.83	The old cor., of Tps. 25 and 26 N., Rs. 1 and 2 W., which is an oak post, burned off at the surface of the ground. I reestablish the cor. at the same point, as follows: Set a cedar post, 3 ft. long, 4 ins. sq., with charred stake and the old post, 24 ins. in the grounds, for cor. of Tps. 25 and 26 N., Rs. 1 and 2 W. marked T. 26 N., S. 31 on N. E., R. 1 W., S. 6 on S. E.,

**SPECIMEN FIELD NOTES.**

**NO. 5.  
TITLE PAGE.  
(See Plate IV.)**

**FIELD NOTES**

**OF THE SURVEY OF THE**

**SUBDIVISION AND MEANDER  
LINES**

**OF**

**TOWNSHIP NO. 15 NORTH, RANGE NO. 20 EAST,**

**OF THE**

**PRINCIPAL BASE AND MERIDIAN**

**IN THE**

**STATE OF MONTANA,**

**AS SURVEYED BY**

**ROBERT ACRES,  
U. S. DEPUTY SURVEYOR,**

**UNDER HIS CONTRACT, No. 207,  
DATED MARCH 22, 1893.**

*Survey commenced August 4, 1893.*

*Survey completed August 19, 1893.*

-183-

*(Pages 184 and 185 deleted. They contain the sample index and preliminary oaths of assistants.)*

*(Pages 186 and 187 were missing from this text.)*

-188-

*Subdivision of T. 15 N., R. 20 E.—Continued.*

T. 25 N., S. 1 on S. W., and  
R. 2 W., S. 36 on N. W. faces; with 6 notches on each  
edge; from which  
A cherry, 6 ins. diam., bears N. 40½° E., 14 lks.  
dist., marked T. 26 N., R. 1 W., S. 31, B. T.  
A white oak, 5 ins. diam., bears S. 51¼° E., 24 lks.  
dist., marked T. 25 N., R. 1 W., S. 6, B. T.  
A hickory, 8 ins. diam., bears S. 37¼° W., 30 lks.  
dist., marked T. 25 N., R. 2 W., S. 1, B. T.  
A chestnut, 6 ins. diam., bears N. 52¼° W., 13 lks.  
dist., marked T. 26 N., R. 2 W., S. 36, B. T.

Land, level.  
Soil, rich loam, 1st rate.  
Timber, oak, hickory, and chestnut.

April 12, 1892.

The field notes of the subdivision of this township read  
in part as follows:

\* \* \* \* \*

"N. 89° 57' W., on a random line bet. secs. 7 and 18.

Set temp. ¼ sec. cor.

The cor. of secs. 7, 12, 13, and 18 cannot be found.

I find the ¼ sec. cor. bet. secs. 13 and 18, which is a

locust post, 1 ft. high, 3 ins. sq., marked and  
witnessed as described by the surveyor general.

Thence I run

North, on a random line bet. secs. 13 and 18

-182-

*Resurvey of the E. bdy. of T. 25 N., R. 2 W., etc.—Concluded.*

Chains.	
40.00	Set temp. sec. cor. At this point I again make careful search for the sec. cor., which is described by the surveyor general, as a post, with pits and mound of earth W. of cor., but am unable to find any traces of post, pits, or mound. Thence, bet. secs. 7 and 12.
79.95	Intersect E. and W. line, 5 lks. E. of the ¼ sec. cor. bet. secs. 7 and 12, which is a sandstone, 5 x 10 x 4 ins. above ground, marked and witnessed as described by the surveyor general.
	Thence I run
	S. 0° 2' E., on a true line bet. secs. 7 and 12.
	Over rolling land.
38.00	Fence, bears E. and W., enter plowed ground.
39.97½	Reestablish the cor. as follows: Set a cedar post, 3 ft. long, 4 ins. sq., with marked stone, 24 ins. in the ground, for cor. of secs. 7, 12, 13, and 20, marked T. 25 N. S. 7 on N. E., R. 2 W. S. 18 on S. E., S. 13 on S. W., and R. 3 W., S. 12 on N. W. faces; with 2 notches on N. and 4 notches on S. edges; dig pits, 18 x 18 x 12 ins., in each sec., 5½ ft. dist.; and raise a mound of earth, 4 ft. base, 2 ft. high, W. of cor.

April 18, 1892."

\* \* \* \* \*

Chains.	
32.50	Leave heavy timber, bears N. W. and S. E.
39.98	Deposit a quart of charcoal, 12 ins. in the ground, for ¼ sec. cor.; dig pits, 18 x 18 x 12 ins., E. and W. of cor., 4 ft. dist.; and raise a mound of earth, 3½ ft. base, 1½ ft. high, over deposit. In E. pit drive a cedar stake, 2 ft. long, 2 ins. sq., 12 ins. in the ground, marked ¼ S. on N. face.
46.50	Enter heavy timber, bears N. and S.
76.00	Leave heavy timber, enter scattering timber, bears N. 25° E. and S. 25° W.
79.96	The cor. of secs. 25, 26, 35, and 36.

	Land nearly level; mostly subject to overflow 2 to 5 ft. deep. Heavily timbered land, 41.50 chs.	
25.36	N. 0° 1' W., bet. secs. 25 and 26. Over level bottom land, through scattering timber. Right bank of Yellowstone River. Set a locust post, 3 ft. long, 4 ins. sq., 24 ins. in the ground, for meander cor. of fracl. secs. 25 and 26, marked M. C. on N., T. 15 N. on S., R. 20 E., S. 25 on E., and S. 26 on W. faces; from which A cottonwood, 12 ins. diam., bears S. 18¼° E., 16 lks. dist., marked T. 15 N., R. 20 E., S. 25, M. C. B. T. A sycamore, 31 ins. diam., bears S. 74½° W., 25 lks. dist., marked T. 15 N., R. 20 E., S. 26, M. C. B. T.	40.00 79.98
26.00	Enter shallow channel, 1 to 2 ft. deep. Across shallow channel, 64 lks. wide, to sand bar parallel to river bank; thence on sand bar.	58.00
32.12	To right bank of main channel, course E.; point for triangulation.	79.98
40.00	Point for ¼ sec. cor. falls in river. To determine the dist. across, I set a flag on line, on left bank; then measure a base, N. 89° 59' E., 20.00 chs. to a point, from which the flag bears N. 49° 06' W.; from the flag the E. end of base bears S. 49° 6' E.; therefore, the dist. is $\tan. 40^\circ 55' \times \text{base}$ , or $0.867 \times 20.00 = 17.34$ chs., <sup>81</sup> making the whole distance from meander cor., $0.64 + 6.12 + 17.34 = 24.10$ chs., which added to 25.36, makes	20.00 39.98 21.00 40.00
49.46	To left bank of Yellowstone River; bank, 12 ft. high. Deposit a marked stone, 12 ins. in the ground for meander cor. of fracl. secs. 25 and 26, dig a pit, 36 x 36 x 12 ins., 5 ft. N. of cor. and raise a mound of earth, 4 ft. base, 2 ft. high, over deposit. In the pit drive a cedar stake, 2 ft. long, 2 ins. sq., 12 ins. in the ground, marked M. C. on S., T. 15 N. on N., R. 20 E., S. 26 on W., and S. 25 on E. faces. Thence over level bottom land. Some small cottonwoods, none within limits suitable for bearing trees.	73.50 78.00 80.00
52.60	Leave bottom, begin ascent, bears E. and W.	
53.60	Top of ascent and edge of sandy plain, 40 ft. above river, bears E. and W.	
55.70	Wire fence, bears E. and W.	40.00
62.80	Telegraph line, bears E. and W.	80.01
80.00	Set a cedar post, 3 ft. long, 4 ins. sq., with marked stone, 24 ins. in the ground, for cor. of secs. 23, 24, 25, and 26, marked T. 15 N., S. 24 on N. E., R. 20 E., S. 25 on S. E., S. 26 on S. W., and S. 23 on N. W. faces; with 2 notches on S. and 1 notch on E. edges; dig pits, 18 x 18 x 12 ins. in each sec. 5½ ft. dist.; and raise a mound of earth, 4 ft. base, 2 ft. high, W. of cor. Land, level.	40.00½ 80.01

-189-

*Subdivision of T. 15 N., R. 20 E.—Continued.*

Chains.	Soil, alluvia land sand; 1st and 2nd rate. Timber, cottonwood and sycamore.
---------	--

August 5: At this cor. I set off 16° 47' N., on the decl. arc; and, at 0<sup>h</sup> 6<sup>m</sup> p. m., 1. m. t., observe the sun on the meridian; the resulting lat. is 45° 47'.0 or about 0'.3 greater than the proper lat.

S. 89° 56' E., on a random line bet. secs. 24 and 25.  
Set temp. ¼ sec. cor.  
Intersect E. bdy. of Tp. 3 lks. N. of cor. of secs. 19, 24, 25, and 30, which is a sandstone, 5 x 9 x 4 ins. above ground, marked and witnessed as described by the surveyor general.  
Thence I run  
N. 89° 55' W., on a true line bet. secs. 24 and 25.  
Over level land.  
Fletcher's Station bears S. 64° W.  
Set a cedar post, 3 ft. long, 3 ins. sq., with marked stone, 24 ins. in the ground, for ¼ sec. cor., marked ¼ S. on N. face; dig pits, 18 x 18 x 12 ins., E. and W. 3 ft. dist.; and raise a mound of earth, 3½ ft. base, 1½ ft. high, N. of cor.  
Fletcher's Station bears S. 7° E.  
Short Creek, 3 lks. wide, alkali water, 8 ins. deep, course S. 20° E.  
The cor. of secs. 23, 24, 25, and 26.  
Land, level.  
Soil, sandy; 3rd rate.  
No timber.

N. 0° 1' W., bet. secs. 23 and 24.  
Over level land.  
Enter alkali flat, bears N. 70° W. and S. 70° E.  
Set a sandstone, 16 x 8 x 16 ins., 11 ins. in the ground, for ¼ sec. cor., marked ¼ on W. face; dig pits, 18 x 18 x 12 ins., N. and S. of stone, 3 ft. dist., and raise a mound of earth, 3½ ft. base, 1½ ft. high, W. of cor.  
Alkali flat extends about 65.00 chs. E. and 35.00 chs. W.  
Leave alkali flat, bears E. and W.  
Alkali creek (dry), course E.  
Set a sandstone, 20 x 7 x 5 ins., 15 ins. in the ground, for cor. of secs. 13, 14, 23 and 24, marked with 3 notches on S. and 1 notch on E. edges; dig pits, 18 x 18 x 12 ins., in each sec., 5½ ft. dist.; and raise a mound of earth, 4 ft. base, 2 ft. high, W. of cor.  
Land, level.  
Soil, sandy and alkali; 4th rate.  
No timber.

S. 89° 55' E., on a random line, bet. secs. 13 and 24.  
Over level land.  
Set temp. ¼ sec. cor.  
Intersect E. bdy. of the Tp. at the cor. of secs. 13, 18, 19, and 24, which is a locust post 1 ft. above ground, 4 ins. sq., marked and witnessed as described by the surveyor general.  
Thence I run  
N. 89° 55' W., on a true line bet. secs. 13 and 24,  
Over sandy alkali land.  
Set a juniper post, 3 ft. long, 3 ins. sq., with marked stone, 24 ins. in the ground, for ¼ sec. cor. marked ¼ S., on N. face; dig pits, 18 x 18 x 12 ins., E. and W. of post, 3 ft. dist.; and raise a mound of earth, 3½ ft. base, 1½ ft. high, N. of cor.  
The cor. of secs. 13, 14, 23, and 24.  
Alkali creek (now dry), runs eastward about 4.00 chs. south of this line.  
Land, level.  
Soil, alkali sand; 4th rate.  
No timber.

81. See page 136.

Subdivision of T. 15 N., R. 20 E.—Continued.

Chains.	N. 0° 1' W., bet. secs. 13 and 14. Over level land.
40.00	Set an oak post 3 ft. long, 3 ins. sq., with quart of charcoal, 24 ins. in the ground, for ¼ sec. cor., marked ¼ S. on W. face; dig pits 18 x 18 x 12 ins. N. and S. of post, 3 ft. dist., and raise a mound of earth, 3½ ft. base, 1½ ft. high, W. of cor. Thence gradually ascending.
58.00	Begin steep ascent, sloping S. W.; broken stony ground.
80.00	Set a limestone, 20 x 8 x 6 ins., 15 ins. in the ground, for cor. of secs. 11, 12, 13, and 14, marked with 4 notches on S., and 1 notch on E. edges; and raise a mound of stone, 2 ft. base, 1½ ft. high, W. of cor. Pits impracticable. This cor. is about 150 ft. above last ¼ sec. cor. Land, level and mountainous. Soil, sandy and rocky; 3rd and 4th rate. No timber. Mountainous land, 22.00 chs.
40.00	S. 89° 55' E., on a random line, bet. secs. 12 and 13. Point for ¼ sec. cor. falls in Rancho San Blas.
80.03	Intersect E. bdy. of Tp. 7 lks. N. of the cor. of secs. 7, 12, 13, and 18, which is a sandstone 5 x 6 x 6 ins. above ground, marked and witnessed as described by the surveyor general. Thence, I run N. 89° 52' W., on a true line bet. secs. 12 and 13. Over level land.
31.49	Intersect E. bdy. of Rancho San Blas, at a point, from which the 5 mile post on the rancho bdy. bears S. 33° E. 7.00 chs. dist. Set a limestone, 15 x 8 x 5 ins., 10 ins. in the ground, for closing cor. of frac. secs. 12 and 13, marked C. C. on E. and S. B., on W. faces; dig pits, crosswise on each line, 30 x 24 x 12 ins., N. 33° W., 3 ft., and 24 x 18 x 12 ins., E. of stone, 7 ft. dist.; and raise a mound of earth, 4 ft. base, 2 ft. high, E. of cor. Thence, across the rancho on a blank line.
67.07	Intersect W. bdy. of Rancho San Blas at a point, from which the 3½ mile post on the rancho bdy., bears N. 19½° W., 12.20 chs. dist. Set a granite stone, 15 x 7 x 6 ins., 10 ins. in the ground, for closing cor. of frac. secs. 12 and 13, marked S. B. on E., with 4 grooves on S. and C. C. on W. faces; and raise a mound of stone 2 ft. base, 1½ ft. high, W. of cor. Pits impracticable. This cor. is on a granite ridge 220 ft. above closing cor. on E. bdy. of the rancho. Thence, over rough stony ground.
76.00	Begin descent of rocky slope, bears N. and S.
80.03	The cor. of secs. 11, 12, 13, and 14. This cor. is 40 ft. below top of ridge. Land, level and mountainous. Soil, sandy loam and stony; 3rd and 4th rate. No timber Across Rancho San Blas, 35.58 chs. of blank line. Mountainous land, 12.96 chs.
	August 5: At 4 <sup>h</sup> 35 <sup>m</sup> p. m., l. m. t., I set off 45° 49' on the lat. arc; 16° 45' N., on the decl. arc; and determine a true meridian with the solar, at the corner of secs. 11, 12, 13, and 14. Thence I run N. 0° 1' W., bet. secs. 11 and 12. Ascend over rough stony ground sloping W.
11.00	Top of ascent, bears about N. 50° W., and S. 50° E. Thence over level land.

Intersect W. bdy. of Rancho San Blas at a point from which the N. W. cor. of the rancho bears N. 19½° W., 7.40 chs. dist.

Subdivision of T. 15 N., R. 20 E.—Continued.

Chains.	Set a cedar post, 3 ft. long, 4 ins. sq., with marked stone, 24 ins. in the ground, for closing cor. of frac. secs. 11 and 12, marked S. B. on E., C. C. T. 15 N., R. 20 E. on S., and S. 11 on W. faces; dig pits, crosswise on each line, 30 x 24 x 12 ins., N. 19½° W., 3 ft., and 24 x 18 x 12 ins., S. of stone, 7 ft. dist.; and raise a mound of earth, 4 ft. base, 2 ft. high, S. of cor. Thence, across the rancho on a blank line.
40.00	The point for ¼ sec. cor. falls in the rancho.
44.32	Intersect N. bdy. of Rancho San Blas at a point from which the N. W. cor. of the rancho bears S. 73° W., 2.58 chs. dist. Set a juniper post 3 ft. long, 4 ins. sq., with a quart of charcoal, 24 ins. in the ground, for closing cor. of frac. secs. 11 and 12, marked C. C., T. 15 N., R. 20 E. on N., S. B. on S., and S. 11 on W. faces; dig pits, crosswise on each line, 30 x 24 x 12 ins., S. 73° W., 3 ft., and 24 x 18 x 12 ins., N. of stone, 7 ft. dist., and raise a mound of earth, 4 ft. base, 2 ft. high, N. of cor.
	Leave rancho, enter public land; thence, over rolling ground.
59.50	Branch, 6 lks. wide, course S. E.
80.00	Deposit a marked stone, 12 ins. in the ground, for cor. of secs. 1, 2, 11, and 12, dig pits, 18 x 18 x 12 ins., in each sec., 4 ft. dist. and raise a mound of earth, 4 ft. base, 2 ft. high, over deposit. In S. E. pit, drive a cedar stake, 2 ft. long, 2 ins. sq., 12 ins. in the ground, marked T. 15 N., S. 1 on N. E., R. 20 E., S. 12 on S. E., S. 11 on S. W., and S. 2 on N. W. faces; with 5 notches on S. and 1 notch on E. edges. Land, mountainous and level. Soil stony, clay, and loam; 3rd and 4th rate. No timber. Across Rancho San Blas, 7.72 chs. of blank line. Mountainous land, 11.00 chs.
	S. 89° 52' E., on a random line bet. secs. 1 and 12.
40.00	Set temp. ¼ sec. cor.
80.04	Intersect E. bdy. of Tp.; 7 lks. N. of cor. of secs. 1, 6, 7, and 12 which is a juniper post, 1 ft. high, 4 ins. sq., marked and witnessed as described by the surveyor general. Thence I run N. 89° 49' W., on a true line bet. secs. 1 and 12. Over rolling land. Enter oak timber, bears N. 20° E. and S. 20° W. Begin ascent of ridge, bears N. 27° E. and S. 27° W. Top of ridge, 50 ft. high, bears N. 27° E. and S. 27° W. Begin descent, bears N. 30° E. and S. 30° W. Foot of descent, bears N. 33° E. and S. 33° W. An oak, 12 ins. diam., on line, I mark with 2 notches on E. and W. sides.
7.00	
9.00	
11.50	
13.60	
16.50	
18.07	
40.02	Set a cedar post, with charred stake, 24 ins in the ground for ¼ sec. cor., marked ¼ S. on N. face; dig pits, 18 x 18 x 12 ins., E. and W. of post, 3 ft. dist.;

and raise a mound of earth, 3½ ft. base, 1½ ft. high, N. of cor.  
 43.00 Ravine, 2.00 chs. wide, 18 ft. deep, course S. 20° W.  
 51.50 Ravine, 3.00 chs. wide, 22 ft. deep, course S. 30° W.  
 59.50 Ravine, 3.50 chs. wide, 25 ft. deep, course S. 20° E.  
 72.00 Leave oak timber, bears N. and S.  
 80.04 The cor. of secs. 1, 2, 11 and 12.  
 Land, rolling.  
 Soil, sandy loam; 3d rate.  
 Timber, oak.

-192-

*Subdivision of T. 15 N., R. 20 E.—Continued.*

Chains.	N. 0° 1' W., on a random line bet. secs. 1 and 2.
40.00	Set temp. ¼ sec. cor.
79.77	Intersect N. bdy. of Tp. at cor. of secs. 1, 2, 35, and 36, which is a limestone, 6 x 6 x 5 ins., above ground, marked and witnessed as described by the surveyor general. Thence I run S. 0° 1' E. on a true line bet. secs. 1 and 2. Over rolling land.
30.50	Ravine, 3.50 chs. wide, 30 ft. deep, course N. 70° E.
39.77	Deposit a marked stone, 12 ins. in the ground, for ¼ sec. cor.; dig pits, 18 x 18 x 12 ins. N. and S. of cor., 4 ft. dist.; and raise a mound of earth, 3¼ ft. base, 1½ ft. high, over deposit. In S. pit drive a cedar stake, 2 ft. long, 2 ins. sq., 12 ins. in the ground marked ¼ S. on W. face.
79.77	The cor. of secs. 1, 2, 11, and 12. Land, rolling. Soil, clay and loam; 3rd and 4th rate. No timber.
	Aug. 5, 1893.
	From the cor. of secs. 2, 3, 34, and 35, on S. bdy. of the Tp., which is a locust post, 4 ins. sq., 12 ins. high, marked and witnessed as described by the surveyor general, I run N. 0° 2' W., bet. secs., 34 and 35. Over local bottom land.
40.00	Set a cedar post, 3 ft. long, 3 ins. sq., with marked stone, 24 ins. in the ground, for ¼ sec. cor. marked ¼ S., on W. face; dig pits, 18 x 18 x 12 ins., N. and S. of post, 3 ft. dist.; and raise a mound of earth, 3½ ft. base, 1½ ft. high, W. of cor.
42.00	Begin ascent of sand hills, bears N. 70° E. and S. 70° W.
46.00	Top of sand ridge, 35 ft. high, bears N. 65° E. and S. 65° W., begin descent.
50.50	Foot of descent, bears N. 70° E. and S. 70° W.; thence, over sandy plain, gently ascending.
80.00	Set a locust post, 3 ft. long, 4 ins. sq., with quart of charcoal, 24 ins. in the ground, for cor. of sec. 26, 27, 34 and 35, marked T. 15 N., S. 26 on N. E., R. 20 E., S. 25 on S. E., S. 34 on S. W., and S. 27 on N. W. faces; with 1 notch on S. and 2 notches on E. edges; dig pits, 18 x 18 x 12 ins., in each sec., 5½ ft. dist., and raise a mound of earth, 4 ft. base, 2 ft. high, W. of cor. Land, level. Soil, alluvial and sandy; 1st and 4th rate. No timber.
40.00	S. 89° 57' E., on a random line bet. secs. 26 and 35.
48.13	Set temp. ¼ sec. cor. To left bank of Yellowstone River, set temp. meander cor. To determine the dist. across <sup>82</sup> , I set a flag on line on right bank of the river; then measure a base line S. 22°

58° E. 15.00 chs. to a point, whence the flag bears N. 41° 47' E. From the flag the S. end of the base bears S. 41° 47' W.; therefore the angles taken in order of measurement are respectively 66° 59', 64° 48', and 48° 16'; their sum being 180° 03', or 3' too great. I diminish each angle by one-third of the excess and compute the distance across the river, as follows:  
 $\frac{\sin 64^\circ 47'}{\sin 48^\circ 15'} \times \text{base, or } \frac{0.905 \times 15}{0.746} = 18.19 \text{ chs}^{81}$ ; also,  
 48.13 + 18.19 makes  
 66.32 To right bank of river; set temp. meander cor.  
 80.06 Intersect N. and S. line, 3 lks. S. of cor. of secs. 25, 26, 35, and 36; thence I run  
 N. 89° 58' W., on a true line bet. secs. 26 and 35.

-193-

*Subdivision of T. 15 N., R. 20 E.—Continued.*

Chains.	Over level bottom land, through scattering timber.
13.74	To right bank of Yellowstone River. Set a limestone, 19 x 7 x 5 ins., 15 ins. in the ground, for meander cor. of fracl. secs. 26 and 35, marked M. C. on W. face, with 1 groove on S. face; from which A sycamore, 19 ins. diam., bears N. 49¼° E., 26 lks. dist., marked T. 15 N., R. 20 E., S. 26, M. C. B. T.
31.93	To left bank of Yellowstone River. A sycamore, 13 ins. diam., for meander cor. of fracl. secs. 26 and 35, I mark M. C on E., T. 15 N. on W., R. 20 E., S. 35 on S., and S. 26° on N. sides; dig a pit, 36 x 36 x 12 ins., 8 ft. W. of tree, and raise a mound of earth, 4 ft. base, 2 ft. high, W. of cor.
37.50	Leave scattering timber, bears N. W. and S. E.
40.03	Set a cedar post, 3 ft. long, 3 ins. sq., with marked stone, 24 ins. in the ground, for ¼ sec. cor. marked ¼ S., on N. face; dig pits, 18 x 18 x 12 ins., E. and W. of post, 3 ft. dist.; and raise a mound of earth, 3½ ft. base, 1½ ft. high, N. of cor.
80.06	The cor. of secs. 26, 27, 34, and 35. Land, level. Soil, alluvial and sandy; 1st and 3rd rate. Timber, sycamore and cottonwood.
	N. 0° 2' W., bet. secs. 26 and 27. Over nearly level land.
4.50	Road from Mound City to Lake City, bears N. 65° W. and S. 60° E.
40.00	Set a locust post, 3 ft. long, 3 ins. sq., with marked stone, 24 ins. in the ground, for ¼ sec. cor. marked ¼ S. on W. face; dig pits, 18 x 18 x 12 ins., N. and S. of post, 3 ft. dist.; and raise a mound of earth, 3½ ft. base, 1½ ft. high, W. of cor.
44.20	Telegraph line, bears N. 70° E. and S. 70° W.
48.50	Spring branch, 2 lks. wide, course S. E.; flows from a spring of pure water, 3 ft. diam., 2 ft. deep, which bears N. 63° W., 4.00 chs. dist.
57.50	Road from Mound City to Lake City, bears N. 60° E. and S. 60° W.
80.00	Set a cedar post, 3 ft. long, 4 ins. sq., with marked stone, 24 ins. in the ground, for cor. of secs. 22, 23, 26, and 27, marked T. 15 N., S. 23 on N. E., R. 20 E., S. 26 on S. E., S. 27 on S. W., and S. 22 on N. W. faces; with 2 notches on S. and E.

82. The triangulation will always be made on the random line when a random line is run. See page 61 and Plate II, fig. 4.

	edges; dig pits, 18 x 18 x 12 ins., in each sec., 5½ ft. dist.; and raise a mound of earth, 4 ft. base, 2 ft. high, W. of cor.	79.90
	Land, level. Soil, sandy loam; 1st and 2nd rate. No timber.	
40.00	S. 89° 58' E., on a random line bet. secs. 23 and 26. Set temp. ¼ sec. cor.	
80.01	Intersect N. and S. line, 5 lks. N. of cor. of secs. 23, 24, 25, and 26. Thence I run N. 89° 56' W., on a true line bet. secs. 23 and 26. Over level land.	38.00
40.00½	Deposit a quart of charcoal, 12 ins. in the ground, for ¼ sec. cor.; dig pits, 18 x 18 x 12 ins., E. and W. of cor., 4 ft. dist.; and raise a mound of earth, 3½ ft. base, 1½ ft. high, over deposit. In E. pit drive a cedar stake, 2 ft. long, 2 ins. sq., 12 ins. in the ground, marked ¼ S., on N. face.	40.00
53.00	Road from Mound City to Lake City, bears N. 50° E. and S. 50 W.; wire fence bears S. 53° E.	66.00
80.01	The cor. of secs. 22, 23, 26, and 27.	80.00

(Pages 194 through 203 deleted. They contain sample field notes in the same vein and style.)

-204-

*Subdivision of T. 15 N., R. 20 E.—Continued.*

Chains.	N. 0° 4' W., bet. secs. 16 and 17. Over level land.
34.00	S. E. cor. of James Wilkie's field, extends W., 18.00 chs., and along line.
40.00	Set a cedar post, 3 ft. long, 3 ins. sq., with quart of charcoal, 24 ins. the ground, for ½ sec. cor., marked ¼ S., on W. face; dig pits 18 x 18 x 12 ins., N. and S. of post, 3 ft. dist.; and raise a mound of earth, 3½ ft. base, 1½ ft. high, W. of cor.
46.00	Old Military Road, bears N. 65° W. and S. 65° E.
47.00	Branch, 4 lks. wide, pure water, swift current, course S. 40° W. This branch is the outlet of the pond in sec. 16, fed by numerous fine springs in sec. 9.
50.20	Acequia, 8 lks. wide, course N. 86° W. Thence gradually ascending.
80.00	Set a limestone, 21 x 7 x 5 ins., 16 ins. in the ground, for cor. of secs. 8, 9, 16, and 17, marked with 4 notches on S. and E. edges; dig pits, 18 x 18 x 12 ins., in each sec., 5½ ft. dist.; and raise a mound of earth, 4 ft. base, 2 ft. high, W. of cor. Land, level and rolling. Soil, rich loam; 1st rate. No timber.
40.00	S. 89° 59' E., on a random line bet. secs. 9 and 16. Set temp. ¼ sec. cor.
79.90	Intersect N. and S. line 9 lks. N. of cor. of secs. 9, 10, 15, and 16. Thence I run N. 89° 55' W., on a true line bet. secs. 9 and 16. Over rolling land.
31.40	Spring branch, 3 lks. wide, course S.; enters pond about 6.00 chs. S.
39.95	Set a cedar post, 3 ft. long, 3 ins. sq., with marked stone, 24 ins. in the ground, for ¼ sec. cor., marked ¼ s. on N. face; dig pits, 18 x 18 x 12 ins., E. and W. of post, 3 ft. dist.; and raise a mound of earth, 3½ ft. base, 1½ ft. high, N. of cor.
49.20	Spring branch, 3 lks. wide, course S.; enters pond about 8.00 chs. S.

The branches crossing this line are fed by numerous large springs 4.00 to 10.00 chs. N. of the line.  
The cor. of secs. 8, 9, 16, and 17.  
Land, rolling.  
Soil, gravelly loam; 2nd rate.  
No timber.

N. 0° 4' W., bet. secs. 8 and 9.  
Over rolling land.  
To S. bank of limestone quarry, bears E. and W. To pass the quarry, I offset 2.00 chs. E., then, N. 0° 4' W., on the offset line.  
The point for ¼ sec. cor. falls in quarry. Continue offset line to 40.60 chs.; then, W., 2.00 chs., to true line.  
Set a limestone, 15 x 9 x 5 ins., 10 ins., in the ground, for witness cor. to ¼ sec. cor. marked W. C. ¼ on W. face; and raise a mound of stone, 2 ft. base, 1½ ft. high, W. of cor. Pits impracticable.  
Middle of single track of the Montana and Manitoba Railroad, bears N. 42° E. and S. 42° W.  
Telegraph line, bears N. 42° E. and S. 42° W.  
Set a limestone, 17 x 9 x 5 ins., 12 ins. in the ground, for cor. of secs. 4, 5, 8, and 9, marked with 5 notches on S. and 4 notches on E. edges; dig pits, 18 x 18 x 12 ins., in each sec., 5½ ft. dist.; and raise a mound of earth, 4 ft. base, 2 ft. high, W. of cor.  
From this cor. the U.S. mineral monument in sec. 5 bears N. 59½° W.  
Soil, thin and gravelly, with many limestone outcrops; 3rd and 4th rate.  
No timber.

August 14: at 4<sup>h</sup> 30<sup>m</sup> p.m. l. m. t., I set off 45° 49' on the lat. arc; 14° 6' N. on the decl. arc; and determine a true meridian with the solar, at the cor. of secs. 4, 5, 8 and 9.  
Thence I run  
S. 89° 55' E., on a random line bet. secs. 4 and 9.

-205-

*Subdivision of T. 15 N., R. 20 E. — Continued.*

Chains.	
40.00	Set temp. ¼ sec. cor.
79.94	Intersect N. and S. line, 5 lks. S. of cor. of secs. 3, 4, 9, and 10. Thence I run N. 89° 57' W., on a true line bet. secs. 4 and 9. Descend through heavy pine timber.
20.00	Foot of spur, 300 ft. below sec. cor.; leave heavy pine timber, bears N. and S.
39.50	Wood road, bears N. 20° E. and S. 20° W.
39.97	Set a limestone, 18 x 18 x 6 ins., 12 ins. in the ground, for ¼ sec. cor., marked ¼ on N. face; dig pits, 18 x 18 x 12 ins., E. and W. of stone, 3 ft. dist.; and raise a mound of earth, 3½ ft. base, 1½ ft. high, N. of cor.
68.50	Middle of single track of the Montana and Manitoba Railroad bears N. 38° E. and S. 38° W.
70.20	Telegraph line bears N. 38° E. and S. 38° W.
79.94	The cor. of secs. 4, 5, 8, and 9. Land, mountainous. Soil, thin and gravelly; 3rd and 4th rate. Timber, Pine. Mountainous or heavily timbered land, 20.00 chs.
40.00	N. 0° 4' W., on a random line bet. secs. 4 and 5. Set temp. ¼ sec. cor.
79.96	Intersect N. bdy. of the Tp. 2 lks. W. of cor. of secs. 4, 5, 32, and 33. Thence I run S. 0° 3' E., on a true line bet. secs. 4 and 5.

4.00	Over ridges and ravines; ascend.	14.50	Begin ascent, bears N. and S.
10.00	Top of spur, bears E. and W.; descend.	16.50	Top of ascent and edge of sandy plain, bears N. and S.
16.00	Ravine 20 ft. deep, course E., ascend.	28.50	A fine spring of good water, 3 ft. diam.; 1 ft. deep, bears S., 2.50 chs. dist.
27.00	Top of spur, 40 ft. above ravine, bears S. 70° E. and N. 70° W.; descend.		The N. E. cor. of James Parker's Desert Land Claim, a mound of stone, without marks, bears N. 2¼° E.
32.00	Ravine, 30 ft. deep, course S. 80° E.; ascend.		Set a sandstone, 18 x 6 x 5 ins., 12 ins. in the ground, for ¼ sec. cor., marked ¼ on N. face; dig pits, 18 x 18 x 12 ins., E. and W. of stone, 3 ft. dist.; and raise a mound of earth, 3½ base, 1½ ft. high, N. of cor.
37.00	Top of spur, bears S. 85° E. and N. 85° W.; descend.	39.98½	From this ¼ sec. cor. the above described S. E. cor. of James Parker's Desert Land Claim bears S. 14½° E.
39.96	Ravine, 25 ft. deep, course S. 65° E.; ascend.		The cor. of secs. 29, 30, 31, and 32.
	Set a limestone, 15 x 6 x 6 ins. 10 ins. in the ground, for ¼ sec. cor., marked ¼ on W. face; and raise a mound of stone, 2 ft. base, 1½ ft. high, W. of cor. Pits impracticable.		Land, level.
	This cor. stands on the N. E. slope of a spur descending southeasterly; ascend.	79.97	Soil, sand; 4th rate.
50.00	Top of spur, bears E. and W., about 35 ft. above ¼ sec. cor., bears E. and W.; descend.		No timber.
55.00	Ravine, 20 ft. deep, course N. 55° E., ascend.		
62.00	Top of low spur, bears E. and W.; descend.		
74.00	Foot of slope, bears N. 40° E. and S. 65° W.		
79.96	The cor. of secs. 4, 5, 8, and 9.		
	Land, mountainous.	40.00	
	Soil, rocky; 4th rate.	78.35	
	No timber.		
	Mountainous land, 74.00 chs.		
August 14, 1893.			
	August 15: At 7 <sup>h</sup> 35 <sup>m</sup> a.m., l. m. t., I set off 45° 45' on the lat. arc; 13° 54' N., on the decl. arc; and determine true meridian with the solar, at the cor. of sec. 5, 6, 31, and 32; which is a limestone, 5 x 8 x 6 ins., above ground; marked and witnessed as described by the surveyor general.	38.35	
	Thence I run N. 0° 5' W., bet. secs. 31 and 32.		
	Over level land.		
6.50	Trail, bears E. and W.	78.35	
	The S. W. cor. of James Parker's Desert Land Claim, which is an oak post, 2 ft. high, 6 ins. sq., marked J. p. D. L. C. 3, bears N. 49½° W.		
	The S. E. cor. of the same claim, which is a round pine post, 3 ft. high, 6 ins. diam., marked J. P. D. L. C. 4, bears N. 66° E.		

-206-

*Subdivision of T. 15 N., R. 20 E. — Continued.*

Chains.	
40.00	Set a locust post, 3 ft. long, 3 ins. sq., with marked stone, 24 ins. in the ground, for ¼ sec. cor., marked ¼ S. on W. face; dig pits, 18 x 18 x 12 ins., N. and S. of post, 3 ft. dist.; and raise a mound of earth, 3½ ft. base, 1½ ft. high, W. of cor.
80.00	Set a limestone, 20 x 7 x 5 ins., 15 ins. in the ground, for cor. of secs. 29, 30, 31, and 32, marked with 1 notch on S. and 5 notches on E. edges; dig pits, 18 x 18 x 12 ins., in each sec., 5½ ft. dist.; and raise a mound of earth, 4 ft. base, 2 ft. high, W. of cor.
	From this cor. the above described S. W. cor. of James Parker's Desert Land Claim bears S. 29¼° W.
	The N. W. cor., which is a post 3 ft. long, 5 ins. sq., marked J. P. D. L. C. 2, bears N. 42° W.
	Land, level.
	Soil, sand; 4th rate.
	No timber.
40.00	S. 89° 57' E., on a random line bet. secs. 29 and 32.
79.97	Set temp. ¼ sec. cor.
	Intersect N. and S. line 7 lks. N. of cor. of secs. 28, 29, 32 and 33.
	Thence I run
	N. 89° 54' W., on a true line bet. secs. 29 and 32.
	Over level land.

-207-

*Subdivision of T. 15 N., R. 20 E. — Continued.*

Chains.	
	N. 0° 5' W., bet. secs. 29 and 30.
	Over level land.
40.00	Deposit a marked stone, 12 ins. in the ground, for ¼ sec. cor.; dig pits, 18 x 18 x 12 ins.; N. and S. of cor., 4 ft dist; and raise a mound of earth, 3½ ft. base 1½ ft. high, over deposit. In S. pit drive a cedar stake, 2 ft. long, 2 ins. sq., marked ¼ S., on ¼. face.
	From this ¼ sec. cor. the N. E. cor. of James Parker's Desert Land Claim bears S. 80° E.
56.00	Telegraph line, bears E. and W.
59.00	Road leading to Lake City and Mound City, bears E. and W.
76.50	Begin descent over rocky ground, bears E. and W.
80.00	Set a sandstone, 15 x 8 x 6 ins., 10 ins. in the ground, for cor. of secs. 19, 20, 29, and 30, marked with 2 notches on S. and 5 notches on E. edges; and raise a mound of stone, 2 ft. base, 1½ ft. high, W. of cor. Pits impracticable.
	This cor. stands on stony ground sloping N., about 25 ft. below level of the plain.
	S. 89° 54' E., on a random line bet. secs. 20 and 29.
40.00	Set temp. ¼ sec. cor.
79.93	Intersect N. and S. line at cor. of secs. 20, 21, 28, and 29.
	Thence I run
	N. 89° 54' W., on a true line bet. secs. 20 and 29.
	Over level land.
16.50	Telegraph line, bears N. and S.

21.00	Road leading to Lake City, bears N. and S.
39.96½	Set a cedar post, 3 feet long, 3 ins. sq., with quart of charcoal, 24 ins. in the ground, for ¼ sec. cor. marked ¼ S., on N. face; dig pits, 18 x 18 x 12 ins., E. and W. of post 3 ft. dist. and raise a mound of earth, 3½ ft. base, 1½ ft. high, N. of cor.
63.00	Begin descent from plain, bears N. and S.
66.00	Foot of descent, 35 ft. below plain, bears N. and S.; thence over broken ground to
79.93	The cor. of secs. 19, 20, 29 and 30. Land, level. Soil, sand and stony; 4th rate. No timber.
N. 89° 57' W., on a random line bet. secs. 19 and 30. Over rough stony ground.	
40.00	Set Temp. ¼ sec. cor.
78.21	Intersect W. bdy. of the Tp. 3 lks. N. of the cor. of secs. 19, 24, 25, and 30, which is a juniper post, 18 ins. above ground, 4 ins. sq., marked and witnessed as described by the surveyor general. Thence I run S 89° 58' E., on a true line bet. secs 19 and 30. Over level land.
38.21	Set a maple post, 3 ft. long, 3 ins. sq., with charred stake, 24 ins. in the ground, for ¼ sec. cor. marked ¼ S., on N. face; dig pits, 18 x 18 x 12 ins., E. and W. of post, 3 ft. dist.; and raise a mound of earth, 3½ ft. base, 1½ ft. high, N. of cor.
72.21	Begin ascent, over stony ground.
78.21	The cor. of secs. 19, 20, 29, and 30. Land, level. Soil, sandy loam; 3rd and 4th rate. No timber.
N. 0° 5' W., bet. secs. 19 and 20.	
2.00	Descend over stony ground. Foot of descent, 10 ft. below sec. cor., and 35 ft. below the sandy plain, bears E. and W. Thence gradual descent toward Lin's Lake.

-208-

*Subdivision of T. 15 N., R. 20 E. — Continued.*

Chains.	
32.50	Enter scattering timber, bears E. and W.
40.00	Set a cedar post, 3 ft. long, 3 ins. sq., 24 ins. in the ground, for ¼ sec. cor. marked ¼ S., on W. face; from which A maple, 22 ins. diam., bears N. 22° W., 19 lks. dist., marked ¼ S., B. T. An ash, 13 ins. diam., bears N. 70½° E., 28 lks. dist., marked ¼ S., B. T.
44.50	To bank of Lin's Lake. Set a cedar post, 3 ft. long, 4 ins. sq., 24 ins. in the ground, for meander cor. of fracl. secs. 19 and 20, marked M.C. on N., T. 15 N. on S., R. 20 E., 20 on E., and S. 19 on W. faces; from which A maple, 8 ins. diam., bears S. 22½° E., 21 lks. dist., marked T. 15 N., R. 20 E., S. 20, M.C. B. T. An ash, 12 ins. diam., bears S. 56¼° W., 27 lks. dist., marked T. 15 N., R. 20 E., S. 19, M. C. B. T. Land, gently rolling. Soil, mostly rich loam; 1st rate. Timber, maple, ash and oak.
August 15, 1893.	

August 16: At 7<sup>h</sup> 4<sup>m</sup>. a.m., l. m. t., I set off 45° 48' on the lat. arc; 13° 36' N., on the decl. arc; and determine a true meridian at the cor. of secs. 16, 17, 20 and 21,

	described on page 203; thence I run N. 89° 57' W., on a true line <sup>83</sup> , bet. secs. 17 and 20. Over gently rolling land, descending toward Lin's Lake.
16.40	Telegraph Line, bears N. and S.
20.50	Road to Lake City, bears N. and S.
30.00	Irrigating ditch, 8 lks. wide, course S. 60° W. Enter field cultivated by irrigation; extends N., 5.00 chs., and S. about 10.00 chs.
36.50	Leave field, enter scattering timber, bears N. 65° E. and S. 5° W.
40.00	Set a cedar post, 3 ft. long, 3 ins. sq., 24 ins. in the ground, for ¼ sec. cor., marked ¼ S., on N. face; from which A sycamore, 22 ins. diam., bears N. 22° W., 19 lks. dist., marked ¼ S., B. T. An ash, 13 ins. diam., bears S. 70½° W., 28 lks. dist., marked ¼ S., B. T.
43.20	To bank of Lin's Lake. A sycamore, 18 ins. diam., for meander cor. of fracl. secs. 17 and 20, I mark M.C. on W., T. 15 N. on E., R. 20 E., S. 17 on N., and S. 20 on S. sides; from which An ash, 10 ins. diam., bears N. 40¼° E., 20 lks. dist., marked T. 15 N., R. 20 E., S. 17, M. C. B. T. A maple, 9 ins. diam., bears S. 49½° E., 23 lks. dist., marked T. 15 N., R. 20 E., S. 20, M.C. B. T. Land, gently rolling. Soil, rich loam; 1st rate. Timber, ash, maple, and sycamore.
From the cor. of secs. 8, 9, 16, and 17, described on page 204, I run N. 89° 57' W., on a true line <sup>83</sup> , bet. secs. 8 and 17. Over rolling land. Telegraph line, bears N. 28° W. and S. 28° E.	
39.20	Set a cedar post, 3 ft. long, 3 ins. sq., with charred stake, 24 ins. in the ground, for ¼ sec. cor., marked ¼ S., on N. face; dig pits, 18 x 18 x 12 ins., E. and W. of post, 3 ft. dist.; and raise a mound of earth, 3½ ft. base, 1½ ft. high, N. of cor.
40.00	

-209-

*Subdivision of T. 15 N., R. 20 E.—Continued.*

Chains.	
55.00	Old Military Road, bears N. W. and S. E. The road branches about 2.00 chs. S. E.
60.00	Enter road, leading to Lake City, bears W.; thence, along middle of road.
61.00	Middle of single track of the Montana and Manitoba Railroad, bears N. 60° E. and S. 60° W.
63.50	Telegraph line, bears N. 60° E. and S. 60° W.
80.00	The point for sec. cor. falls in the road; therefore Deposit a marked stone, 24 ins. in the ground, for cor. of secs. 7, 8, 17 and 18. Land, rolling. Soil, sandy loam; 3rd rate. No timber.
0.50	From the cor. for secs. 7, 8, 17 and 18, which falls in road, I run S. 0° 5' E., bet. secs. 17 and 18. Over rolling land; descending towards Lin's Lake. Set a limestone, <sup>84</sup> 15 x 8 x 7 ins., 10 ins. in the ground, for witness cor. to cor. of secs. 7, 8, 17 and 18, marked W. C., on N. E. face; with 4 notches on S.

83. See paragraph 8, page 55.

84. A Witness Corner to a section corner will always have the letters "W. C." conspicuously displayed on the northeast face.



and 5 notches on E. edges; dig pits, 18 x 18 x 12 ins., N. E., S. E., S. W., and N. W. of cor., 5½ ft. dist.; and raise a mound of earth, 4 ft. base, 2 ft. high, W. of cor.

4.00 Telegraph line, bears N. 84° E. and S. 84° W.

5.20 Middle of the single track of the Montana and Manitoba Railroad, bears N. 84° and S. 84° W.

20.19 To bank of Lin's Lake.  
Set a limestone, 15 x 9 x 6 ins., 10 ins. in the ground, for meander cor. of fracl. secs. 17 and 18, marked M. C. on S. face, with 5 grooves on E. face; and raise a mound of stone, 2 ft. base, 1½ ft. high, N. of cor. Pits impracticable.

Limestone outcrops near the lake.  
Land, rolling.  
Soil, rocky; 4th rate.  
No timber.

August 16: At this meander cor. I set off 13° 31' N. on the decl. arc; and at 0<sup>h</sup> 4<sup>m</sup> p. m., l. m. t., observe the sun on the meridian; the resulting lat. is 45° 48'.

---

From the cor. of secs. 7, 8, 17 and 18, established this day, I run

0.50 N. 89° 57' W., on a random line bet. secs. 7 and 18.

40.00 Set temp. ¼ sec. cor.

77.90 Intersect W. bdy. of the Tp., 3 lks. S. of the cor. of secs. 7, 12, 13, and 18, which is a limestone, 6 x 8 x 6 ins. above ground, marked and witnessed as described by the surveyor general.

Thence I run

28.00 S. 89° 56' E., on a true line bet. secs. 7 and 18.

32.00 Over gently rolling ground.

40.00 Intersect the W. bdy. of Lake City.

17.90 The N. W. cor., which is an oak post, 2 ft. above ground, 12 ins. sq., marked N. W. cor. L. C., bears N. 0° 5' W., 40.00 chs. dist. The S. W. cor., which is a limestone, 8 x 6 x 6 ins., above ground, marked S. W. cor. L. C., bears S. 0° 5' E., 29.50 chs. dist.

Methodist church bears S. 33° E.

18.20 Middle of West street, 40 ft wide, bears N. 0° 5' W. and S. 0° 5' E.

23.70 Thence along middle of Fourth street, 60 ft. wide.

27.00 Middle of Cedar street, 60 ft. wide, bears N. 0° 5' W. and S. 0° 5' E.

29.20 Baptist church bears N., 3.00 chs. dist.

29.20 Middle of Pine street, 60 ft. wide, bears N. 0° 5' W. and S. 0° 5' E. Methodist church bears S. 43° W.

35.00 Middle of Main street, 100 ft. wide, bears N. 0° 5' W. and S. 0° 5' E. Court house bears N. 4° W., 22.00 chs. dist. Wharf bears S. 0° 5' E. 16.50 chs dist.

Catholic church bears N. 39° E.

-210-

*Subdivision of T. 15 N., R. 20 E.—Continued.*

Chains.

37.90 Deposit a limestone, 12 x 8 x 6 ins., 24 ins. in the ground, for ¼ sec. cor., marked x ¼; from which  
A granite stone, 16 x 8 x 7 ins., set 11 ins. in the ground, marked W. C. ¼, on N. face, bears N., 45 lks. dist.  
A granite stone 20 x 9 x 6 ins., set 15 ins. in the ground, marked W. C. ¼, on N. face, bears S., 45 lks. dist. Pits impracticable.

No natural bearing objects available.

40.80 Middle of Elm street, 60 ft. wide, bears N. 0° 5' W. and S. 0° 5' E.

46.30 Middle of Walnut street, 60 ft. wide, bears N. 0° 5' W., and S. 0° 5' E. Railroad station bears S. 14 E., 6.00 chs. dist.

51.80 Middle of East street, 40 ft. wide, bears N. 0° 5' W. and

S. 0° 5' E. Catholic church bears N. 21° W.

52.10 Intersect E. bdy. of Lake City. The N. E. cor., which is a limestone, 14 x 9 x 7 ins. above ground, marked N. E. cor. L. C., bears N. 0° 5' W., 40.00 chs. dist. The S. W. cor., which is a limestone, 9 x 6 x 6 ins. above ground, S. W. cor. L. C., bears S. 0° 5' E., 7.53 chs. dist.

Thence along the middle of the Mound City road.

77.90 The cor. of secs. 7, 8, 17, and 18.  
Land, gently rolling.  
Soil, sandy loam; 1st rate.  
No timber.

August 16, 1893.

---

August 17: At 7<sup>h</sup> 4<sup>m</sup> a. m., l. m. t., I set off 45° 49' on the lat arc; 13° 17' N., on the decl. arc; and determine a true meridian with the solar, at the point for cor. of secs. 7, 8, 17 and 18, which falls in the road, and is described on page 209.

Thence I run

N. 0° 5' W., bet. secs. 7 and 8.

Over rolling land.

0.50 Set a limestone<sup>85</sup> 15 x 8 x 7 ins., 10 ins. in the ground, for witness cor. to cor. of secs. 7, 8, 17 and 18, marked W. C., on N. E. face; with 4 notches on S. and 5 notches on E. edges; dig pits, 18 x 18 x 12 ins., N. E., S. E., S. W., and N. W. of cor., 5½ ft. dist.; and raise a mound of earth, 4 ft. base, 2 ft. high, W. of cor.

Road to Lake City, bears N. 75° W. and S. 75° E.

32.00 Old Military Road, bears N. 35° W. and S. 35° E.

40.00 Set a juniper post, 3 ft. long, 3 ins. sq., with marked stone, 24 ins. in the ground, for ¼ sec. cor. marked ¼ S., on W. face; dig pits, 18 x 18 x 12 ins. N. and S. of post, 3t. dist.; and raise a mound of earth, 3½ ft. base, 1½ ft. high, W. of cor.

67.50 S. E. cor. of cemetery bears W., 5.00 chs. dist.

75.50 N. E. cor. of cemetery bears W., 5.00 chs. dist.

80.00 Set a limestone, 20 x 8 x 4 ins., 15 ins. in the ground, for cor. of secs. 5, 6, 7, and 8, marked with 5 notches on S. and E. edges; dug pits, 18 x 18 x 12 ins., in each sec., 5¼ ft. dist., and raise a mound of earth, 4 ft. base, 2 ft. high, W. of cor.

Land, rolling.  
Soil, gravelly loam; 2nd and 3rd rate.  
No timber.

---

S. 89° 57' E., on a random line bet. secs. 5 and 8.

40.00 Set temp. ¼ sec. cor.

79.96 Intersect N. and S. line 3 lks. S. of the cor. of secs. 4, 5, 8 and 9.

Thence I run

N. 89° 58' W., on a true line bet. secs. 5 and 8.

Over rolling land.

12.00 Begin ascent bears N. E. and S. W.

25.00 Top of spur, bears N. and S.; descend.

35.00 Foot of descent, bears N. 35° W. and S. 35° E.

-211-

*Subdivision of T. 15 N., R. 20 E.—Continued.*

Chains.

39.98 Set a limestone, 14 x 8 x 6 ins., 10 ins. in the ground, for ¼ sec. cor. marked ¼ on N. face; dig pits, 18 x 18 x 12 ins., E. and W. of stone, 3 ft. dist.; and raise a mound of earth, 3½ ft. base, 1½ ft. high, N. of cor.

From this ¼ sec. cor. the U. S. mineral monument in sec. 5 bears N. 37° 30' E.

85. See page 48 and footnote.

64.00 Road, bears N. and S.  
79.96 The cor. of secs. 5, 6, 7, and 8.  
Land, rolling.  
Soil, gravelly loam; 2nd and 3rd rate.  
No timber.

---

40.00 N. 89° 56' W., on a random line bet. secs. 6 and 7.  
77.87 Set temp. ¼ sec. cor.  
Intersect W. bdy. of the Tp. 9 lks. S. of the cor. of  
secs. 1, 6, 7, and 12, which is a limestone, 6 x 8 x 6  
ins. above ground, marked and witnessed as described by  
the surveyor general.  
Thence I run  
S. 89° 52' E., on a true line bet. secs. 6 and 7.  
Over rolling land.

37.87 Set a limestone, 15 x 8 x 6 ins., 10 ins. in the ground,  
for ¼ sec. cor., marked ¼ on the N. face; dig pits,  
18 x 18 x 12 ins., E. and W. of stone, 3 ft. dist.; and  
raise a mound of earth, 3½ ft. base, 1½ ft. high,  
N. of cor.

51.00 Old Military road, bears N. 30° E. and S. 30° W.  
57.50 The N. W. cor. of cemetery, bears S., 5.00 chs. dist.  
72.00 The N. E. cor. of cemetery, bears S., 5.00 chs. dist.  
77.87 The cor. of secs. 5, 6, 7, and 8.  
Land, rolling.  
Soil, gravelly loam; 2nd rate.  
No timber.

---

40.00 N. 0° 5' W., on a random line bet. secs. 5 and 6.  
80.05 Set temp. ¼ sec. cor.  
Intersect N. bdy. of the Tp. 3 lks. E. of the cor. of  
secs. 5, 6, 31 and 32, which is a limestone marked and  
witnessed as described by the surveyor-general.  
Thence I run  
S. 0° 6' E., on a true line bet. secs. 5 and 6.  
Over rolling ground.

40.05 Set a limestone, 18 x 8 x 5 ins., 12 ins. in the ground,  
for ¼ sec. cor., marked ¼ on W. face; dig pits, 18 x  
18 x 12 ins., N. and S. of the stone, 3 ft. dist.; and  
raise a mound of earth, 3½ ft. base, 1½ ft. high,  
W. of cor.

80.05 The cor. of secs. 5, 6, 7, and 8.  
Land, rolling.  
Soil, gravelly loam; 2nd rate.  
No timber.

11 a. m., August 17, 1893.

In order to locate Ivy Island, I proceed as follows:  
I begin at the meander cor. of fracl. secs. 17 and 20, at 0<sup>h</sup> 45<sup>m</sup> p.  
m., which being too near noon to secure accurate results with  
the solar, I take a back sight on the cor. of secs. 16, 17, 20 and  
21, prolong the direction, N. 89° 57' W., bet. secs. 17 and 20,  
and set a flag on line, on the S. E. side of the island. To  
determine the distance to the flag, I lay off a base line, S. 30°  
32' W., 36.00 chs., to a point, at which the angle bet. flag and  
meander cor. measures 68° 01'; from the flag, the base line  
subtends an angle of 52° 31'. The sum of the three angles is  
180° 03'; therefore the corrected angles, taken in the order of  
their measurement, are, respectively, 59° 30', 68° 00', and 52°  
30'; and the distance is  
 $\frac{\sin. 68^\circ \times 36}{\sin. 52^\circ 30'}$  or  $\frac{0.9272 \times 36}{0.7934} = 42.07$  chs.<sup>86</sup>

-212-

*Subdivision of T. 15 N., R. 20 E.—Continued.*

Chains.	
36.80	The point for cor. of secs. 17, 18, 19, and 20 falls in the lake; thence N. 89° 57' W. bet. secs. 18 and 19.

5.27 In place of the flag, I  
Set a limestone, 15 x 8 x 6 ins., 10 in. in the ground,  
for meander cor. of fracl. secs. 18 and 19, marked M. C.  
on E. face, with 3 grooves on S. face; dig a pit, 36 x  
36 x 12 ins., 8 ft. W. of stone, and raise a mound of  
earth, 4 ft. base, 2 ft. high, W. of cor.  
Thence I run  
N. 89° 57' W., on a true line bet. secs. 18 and 19.  
Over level land.

9.38 Intersect W. shore of island.  
Set a limestone, 18 x 8 x 5 ins., 12 ins. in the ground,  
for meander cor. of fracl. secs. 18 and 19, marked M. C.  
on W. face; dig a pit, 36 x 36 x 12 ins., 8 ft. E. of  
stone, and raise a mound of earth, 4 ft. base, 2 ft.  
high, E. of cor.

August 17, 1893.

---

To locate a small island called Diamond Rock, in Lin's  
Lake, sec. 19, I proceed as follows:  
From the meander cor. of secs. 19 and 24, on the W. bdy.  
of the township, I set a flag on the south point of the  
island, which bears N. 71° 30' E.; then measure a base  
S. 48° 01' E., 23.14 chs., to a point, from which the  
flag bears N. 8 E.; which gives for the distance to flag  
 $\frac{\sin. 60^\circ 29' \times 23.14}{\sin. 63^\circ 30'}$  or  $\frac{0.87 \times 23.14}{0.8949} = 22.50$  chs., the  
required distance.

22.50 In place of the flag, I  
Set a limestone, 15 x 8 x 6 ins., 12 ins. in the ground,  
for an auxiliary<sup>87</sup> meander cor. in sec. 19, marked A.  
M. C., on S. face; dig a pit, 36 x 36 x 12 ins., 8 ft.  
N. of stone, and raise a mound of earth, 4 ft. base, 2  
ft. high, N. of cor.

August 17, 1893.

*Meanders, T. 15 N., R. 20 E.*

*Meanders of the right bank of Yellowstone River, up stream.*  
I commence at the meander cor. of fracl. secs. 25 and 30,  
on the E. bdy. of the Tp., which is a sandstone, 6 x 9 x  
7 ins. above ground, marked and witnessed as described  
by the surveyor general.  
At this cor., August 8, I set off 45° 46' on the lat. arc;  
16° 1' N., on the decl. arc; and at 7<sup>h</sup> 35<sup>m</sup> a. m., l.  
m. t., determine a true meridian with the solar.  
Thence I run with meanders in sec. 25.  
Through heavy timber.

S. 85° W.	13.00	chs.	Bank 20 ft. high.
S. 72° W.	7.10	"	Bank 9 ft. high
S. 64½° W.	13.00	"	
S. 40° W.	5.40	"	Low bank 5 ft. high. Head of course, leave heavy timber, enter dense willow and cottonwood undergrowth, bears S.
S. 77¼° W.	7.00	"	At 3.20 chs., mouth of Cherry Creek, 14 lks. wide, course N.
N. 76° W.	7.50	"	Bank 7 ft. high. At 2.00 chs., leave dense undergrowth, enter heavy timber, bears S.
S. 80° W.	12.00	"	At end of course, lower end of sand bar, bears N., 2.00 chs. dist.
S. 81° W.	19.39	"	Bank 4 ft. high. At 5.00 chs. leave heavy, enter scattering timber, bears S. To the meander cor. of fracl. secs. 25 and 26.

86. For other methods of computing the distance, see page 136.

87. See pages 44 and 58.

Meanders, T. 15 N., R. 20 E.—Continued.

*Meanders of the right bank of Yellowstone River, up stream—Continued.*

Land, river bottom.  
Soil, alluvial; 1st rate.  
Timber, cottonwood, sycamore, ash, and walnut,  
Heavily timbered land or land covered with dense undergrowth, 70.00 chs.

---

Thence in sec. 26.  
Through scattering timber.  
S. 81° W. 8.70 chs. Bank 8 ft. high.  
S. 70¼° W. 4.90 " At 2.30 chs., upper end of bar, bears N. about 2.00 chs. dist.

S. 44¾° W. 3.60 "  
S. 21° W. 3.50 "  
S. 5¼° W. 4.20 "  
South. 4.30 "  
S. 9¼° E. 3.80 "  
S. 34¼° E. 5.27 " To meander cor. of fracl. secs. 26 and 35.

Land, level.  
Soil, alluvial; 1st rate.  
Timber, scattering ash, hickory, walnut, and cottonwood.

---

Thence in sec. 35.  
August 8: At the meander cor. of fracl. secs. 26 and 35, I set off 15° 57' N., on the decl. arc; and, at 0<sup>h</sup> 5<sup>m</sup> p. m., l. m. t., observe the sun on the meridian; the resulting lat. is 45° 46'.

Through scattering timber.  
S. 28° E., 8.80 chs. Bank 8 ft. high.  
S. 0¾° E., 7.70 " At 4.30 chs., leave scattering timber, enter dense cottonwood and willow undergrowth, bears N. 60° E.

S. 6½° W. 10.00 " Low bank 4 ft. high. At end of course, road to Mound City, bears S. 70° E. Ferry, and road to Lake City, bears N. \_\_\_\_\_ W.

S. 31° W. 12.00 " At 5.50 chs. leave dense undergrowth, bears N. 65° E.; enter Pat Curran's field, bears E. At end of course, house bears S. 62° E., 5.00 chs. dist.

S. 38° W. 5.50 " Bank 13 ft. high. At 5.10 chs., leave Pat Curran's field, fence bears E. At 5.30 chs. middle of road, bears E.

S. 43½° W. 7.70 " At 1.50 chs., N. W. cor. of Alexander's field, bears E., 0.50 chs. dist.

S. 47½° W. 6.50 "  
S. 37° W. 2.00 "  
S. 58° W. 2.10 "  
S. 42¼° W. 5.40 " At 3.30 chs., wire fence, bears S. E.

S. 47° W. 4.80 "  
S. 50° W. 4.90 "  
S. 57° W. 9.50 "  
S. 43½° W. 16.68 " To meander cor. of fracl. secs. 2 and 35, on S. bdy. of the Tp., which is a limestone 5 x 8 x 6 ins. above ground, marked and witnessed as described by the surveyor general.

Land, nearly level.  
Soil, alluvial; 1st rate. North of Curran's field subject

to inundation, 2 to 5 ft. deep.  
Timber, scattering ash, walnut, and cottonwood.  
Dense undergrowth, 18.90 chs.

August 8, 1893.

(Pages 214 through 220 deleted. They contain the remainder of the meanders in the township, general description and final oaths.)

PRIVATE LAND CLAIM SURVEYS.

1. Before ordering any survey of a private land claim the surveyor general will receive full instructions from this office, by which he will be governed in issuing his instructions to the deputy. The instructions to the deputy must be entered in full at the commencement of the field notes of such survey.

2. The instruments used in the survey of private land claims must be the same as those required for the survey of public lands, and must be registered and tested in like manner at the surveyor general's office previous to the deputy's commencing work; and the instructions for the survey of public lands must, as far as applicable, be strictly observed in the survey of private land claims.

3. The true magnetic variation must be noted at the beginning point of each survey, and wherever the variation of the needle is observed to change along the line the same must be noted and the reasons therefor stated, if known.

4. At the end of each mile along a boundary, the character of the soil and amount of timber, grass, etc., will be stated; and the date of each day's work in the field must be noted at the end of the record thereof.

5. The requirements in the "Summary of objects and data required to be noted," as set forth in the instructions for the survey of public lands, must be observed by the deputy in the survey of private land claims. Where practicable, bearings must be taken from at least two points on the line to all prominent or otherwise notable objects in the vicinity, and where only one bearing can be taken the estimated distance must be noted.

6. At the beginning point upon the boundaries of each grant survey, a corner must be established of the same character, size, and materials as prescribed for township corners upon the lines of the survey of public lands, except that only two pits will be dug, one on each side of the corner, on the line. Upon the side of such corner facing the claim, the initial letters of the name of the grant, and immediately under the same the letters "Beg. Cor. 1" (for beginning corner one) must be neatly cut or chiseled.

7. Each of the mile corners or stations of survey must be established in the manner prescribed for the establishment of section corners upon the lines of public surveys, except that they will be marked on the side facing the grant with the initials of the grant and the number of the station or mile, as the case may be; and only two pits will be dug, one on each side of the corner, on the line.

8. Where mile corners are established, except upon meandered portions of the line, half-mile corners will also be estab-

lished in the manner prescribed for the establishment of quarter-section corners upon the lines of public surveys, except that they will be marked upon the side facing the grant with the initials of the grant.

-221-

-222-

9. Such other marks, in addition to those above described, will be placed upon the corners as may be required by the surveyor general in his special written instructions.

10. As far as practicable, bearings and distances must be taken from each of the corners or stations to two or more trees, or prominent natural objects, if any, within a convenient distance, in the same manner as required in the instructions for the survey of public lands, and such trees or objects must be marked with the initials of the grant, and underneath same the letters "B. T." or "B. O.," as the case may be.

11. Witness corners will be established, where necessary, in the same manner as required in the instructions for the survey of public lands.

12. In all cases where the lines of the grant boundary surveys intersect established lines of survey of public lands or private land claims, the course and distance from such point of intersection to the nearest corner on the line of the prior survey must be carefully run, measured, and noted, and whenever necessary such corner must be reestablished.

13. The survey of a private land claim must always be connected by a line actually run and measured in the field with some corner of the public surveys, if any such have been established within a distance not exceeding two miles from any point on the boundary lines of the private land claim.

14. Boundaries or portions of boundaries of previously established grant surveys, which also form a portion of the boundaries of the claim to be surveyed, will be adopted so far as common to both grants, but no payment will be made for such common boundaries unless it is necessary to reestablish the same.

15. The field notes must embrace a full, clear, and concise statement of the deputy's reasons for his location and establishment of each boundary.

16. A general description of each tract must be given at the end of the field notes of the survey of same, which description must embrace a brief statement of the main features of the tract surveyed, character of the land, timber, and other natural growth, kinds of mineral, if any, population of towns and settlements, characteristics of mountains, streams, springs, etc., and such other data as may be of importance.

17. The deputy must particularly note all facts relative to present inhabitancy of the land and designate all tracts occupied by actual settlers or residents.

18. The deputy surveyor must return with the field notes a topographical map or plat of the survey. As far as practicable all objects described in field notes, and the main features of the tract surveyed, including towns, streams, mountains, roads, etc., must be protracted on such plat as accurately as possible.

19. The field-note books must embrace a list of assistants, and preliminary and final oaths, as required in the instructions for the survey of public lands.

20. The deputy will note all objections to his survey that may be brought to his knowledge, and the surveyor general will promptly report to the Commissioner of the General Land Office all complaints made to him, and send up all protests filed in his office, together with a full report thereon.

21. Official plats of the survey of private land claims will not be furnished to any person until the cost of surveying and platting the same shall have been paid to the United States.

## APPENDIX RELATIVE TO ACCOUNTS FOR SURVEYING AND EXAMINATION.

U.S. surveyors general and deputy surveyors are required to comply strictly with the following instructions:

All surveying accounts transmitted to the General Land Office for adjustment must be in duplicate and in a separate letter from that forwarding the plats and field notes of the survey. The name of the deputy surveyor, date and number of the contract, the amount of the estimated liability, and whether said liability is limited or not, should be noted on the face of the deputy's account.

The amount of the account and the appropriation from which it is to be paid should be stated both in the letter of transmittal and in the account rendered. The deputy's affidavit that the survey was executed by him, and that it was just and correct, should be attached to the account.

The date of the surveyor general's approval should appear in the certificate thereto, and the destination of the draft or drafts, the name of the payee or payees, with the post-office address, should be added.

When the survey is chargeable to "Deposits by individuals for surveying the public lands," it should be so stated, and the deposit to which the field work is chargeable should be listed by number and date of certificate of deposit, with number of township and range for which the deposit is made, and the amount of each certificate.

When the amount of an account is in excess of the liability of the contract, a copy of office letter authorizing the excess must always accompany the account.

When stating an expense account for examination in the field or office on surveys, the number of the contract under which the survey was made, the name of the surveyor, with the number of township and range examined, should be inserted in the account, accompanied by a copy of letter of authorization, said account and vouchers to be furnished in duplicate and to have the affidavit of the examiner as to the correctness of the charges and the approval of the surveyor general attached.

When surveys are continued and executed beyond the time limited in the contract and the contract has expired, and there has been no properly-granted extension of time thereto, the compensation of the deputy surveyor for the lines of survey executed after the expiration of the contract will be reduced, and said lines completed at such rates as the Commissioner of the General Land Office may in his judgment determine to be proper, taking into consideration the value of the work and the limitations of the appropriation from which the account must be paid.

The field notes of a U. S. deputy surveyor, which are the

data upon which his surveying account is stated by the surveyor general, and

-223-

-224-

subsequently adjusted by the Commissioner of the General Land Office, should describe the surface, soil, etc., at the end of each mile or fractional mile of survey, and should state the number of chains and links which are "mountainous," "heavily timbered," or covered with "dense undergrowth," using always the exact phraseology of the appropriation act which establishes the rates for said lines of surveys.

By dense undergrowth is meant thick bushes, boughs, or other vegetable growth of such height as to obstruct the use of the transit, and require cutting away to obtain sights along line; also bushes, brush, vines or other vegetation which is of such tangled and difficult character as to seriously impede the work of chaining the line.

Connecting lines, showing closing distances to closing corners, will be paid for at the minimum rate allowed in the contract for that class of line which is run to the closing corner, unless otherwise specially provided in the contract.

The practice of allowing deputies to retrace any and all lines which they may deem necessary in connection with their work, and compensating them therefor, has been discontinued.

If it becomes necessary to retrace any of the exterior lines in order to properly close their lines of survey it must be done at the deputy's own expense as a legitimate contingent in executing the contract. If it should be found to be absolutely necessary to resurvey and retrace any portion of the exterior township lines, except such as are clearly provided for in the article on pages 72, 73, and 74, the deputy should report the facts immediately to the surveyor general and await further instructions. The facts as reported to him will be promptly laid before the Commissioner of the General Land Office, specifying the number of miles of retracement required, and, if such resurvey is authorized, the deputy will be immediately notified. In no other case will any resurvey be paid for which is not specifically authorized by the Commissioner.

### PROCEDURE OF COUNTY AND PRIVATE SURVEYORS IN RESTORING LOST AND OBLITERATED CORNERS AND SUBDIVIDING SECTIONS.

The General Land Office assumes no control or direction over the acts of local and county surveyors in the reestablishment of extinct corners of original surveys. It follows the general rule that disputes, arising from uncertain or erroneous location of original corners, are to be settled by the proper local authorities or by amicable adjustment; and to aid in this result it furnishes a circular pamphlet which is merely advisory and explanatory of the principles which should prevail in performing such duties.

Surveyors who have been United States deputies should bear in mind that in their private capacity they must act under somewhat different rules of law from those governing original surveys, and should carefully distinguish between

the provisions of the statute which guide a Government deputy and those which apply to retracement of lines once surveyed. The failure to observe this distinction has been prolific of erroneous work and injustice to land owners.

The circular on "Restoration of lost and obliterated corners," dated March 13, 1883, and the circular on subdividing a section. dated June 2, 1887, are furnished to applicants.

## INDEX.

	Page.
A.	
Abbreviations allowed in field notes . . . . .	23, 65
Accounts for surveys and examinations . . . . .	223
Acreage of fractional lots, computation of . . . . .	68-70
Affidavits of qualification of sureties . . . . .	16, 17
Affidavits or final oaths of deputy and assistants, forms of . . . . .	63
Alinement, limits of error of, in section and township lines . . . . .	59, 66, 72
Alteration of field notes prohibited . . . . .	64
Annual change of magnetic declination for each State . . . . .	98
Annual magnetic variation, table showing . . . . .	96, 97
Appointment of deputies by surveyor general . . . . .	10, 14
Approval of surveying contract by Commissioner . . . . .	12
Arabic figures to be used in marking at corners . . . . .	22
Areas of certain tracts to appear on plats . . . . .	67
Areas of lots, how computed . . . . .	68-70
Argument, definition given . . . . .	112
Ascertaining true meridian from Polaris, by hour angle . . . . .	109-119
Assistant, discharge or change of duties of . . . . .	65
Assistant, specimen field notes of discharge of . . . . .	149, 200
Assistants, forms of affidavits of . . . . .	63
Astronomical and civil day, difference explained between . . . . .	109, 100
Auxiliary meander corners . . . . .	44, 58, 212
Azimuths of Polaris at elongation, tables of . . . . .	103, 104
Azimuths of Polaris for any hour, table of . . . . .	118, 119
Azimuths of secant to the parallel and offsets in feet, table of . . . . .	121
Azimuths of tangent of the parallel, table of . . . . .	125
B.	
Base and meridian lines, and correction lines . . . . .	10
Base and standard lines surveyed by offsets . . . . .	120-128
Base lines and principal meridians of various States . . . . .	81-84
Base lines, how run . . . . .	51
Bearing trees, location and marking of . . . . .	24, 49, 50
Blazing of trees along line . . . . .	21
Bond and contract for surveying, form of . . . . .	15, 16
Bond, official, of surveyor general . . . . .	10
Bond to be given by deputy surveyor . . . . .	11
Boulder, marked for corner, specimen field notes of . . . . .	157
Boundaries and contents of lands, law for ascertaining . . . . .	12
Boundaries of townships considered defective . . . . .	72

Boundaries of townships, latitude and  
 departure of.....61, 129  
 Boundaries of townships, specimen field notes of ..169-182  
 Boundary corner monuments, descriptions of ..... 45-47  
 Boundary of rancho, specimen notes of  
 line intersecting.....190, 191  
 Bushes to be lopped along line ..... 21

C.

Cassiopeia, diagram of constellation .....108  
 Cedar and live-oak lands reserved for navy .....13  
 Certificates of deposit by settlers, for surveys.....13  
 Chain, standard to be kept by deputy.....20  
 Chaining, double, specimen field  
 notes of.....142-158, 164-167

-225-

*(Pages 226 through 236 deleted. They contain the remainder of the Index.)*

*[Ed. Note: The 1894 Manual was the first Manual to contain a detailed Index.]*







Fig. 1.

# SECANT METH

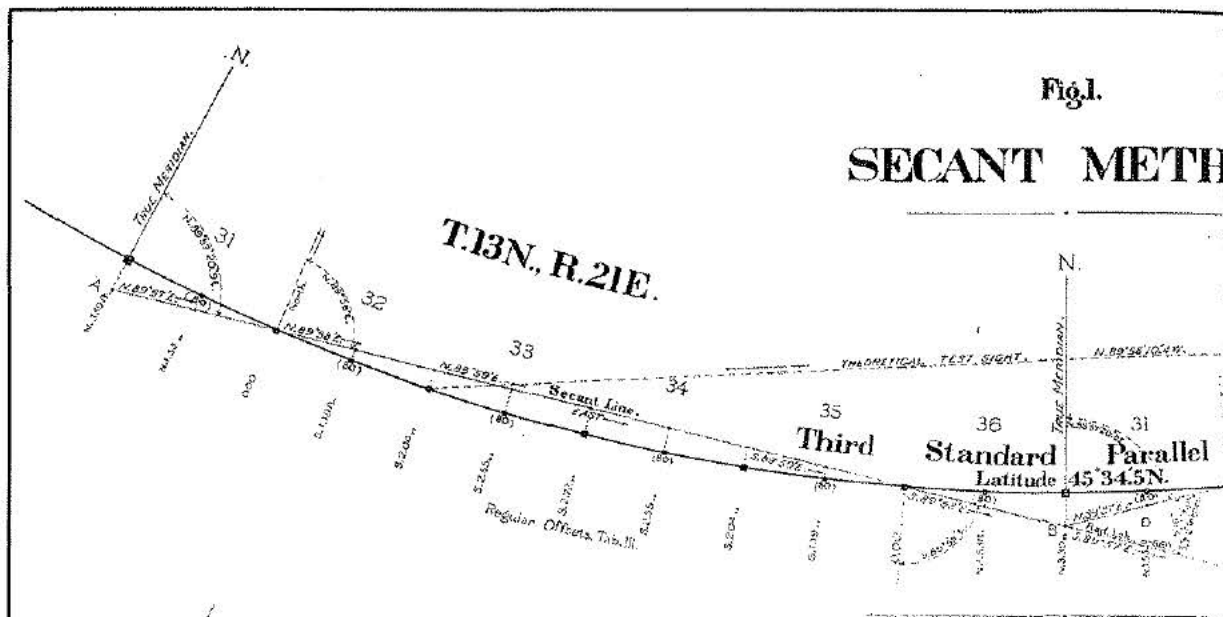

Fig. 2.

Illustrating the Recovery of the Theoretical Position from the Established Position when the latter deviates from the former by less than One Minute of Arc as determined by Regular Offsets Table III.

Distance from Secant to Parallel	0	25	50	75	100
Corner off	0	1.5	3.0	4.5	6.0
Distance from Secant to Parallel	0	1.5	3.0	4.5	6.0
Distance from Secant to Parallel	0	1.5	3.0	4.5	6.0

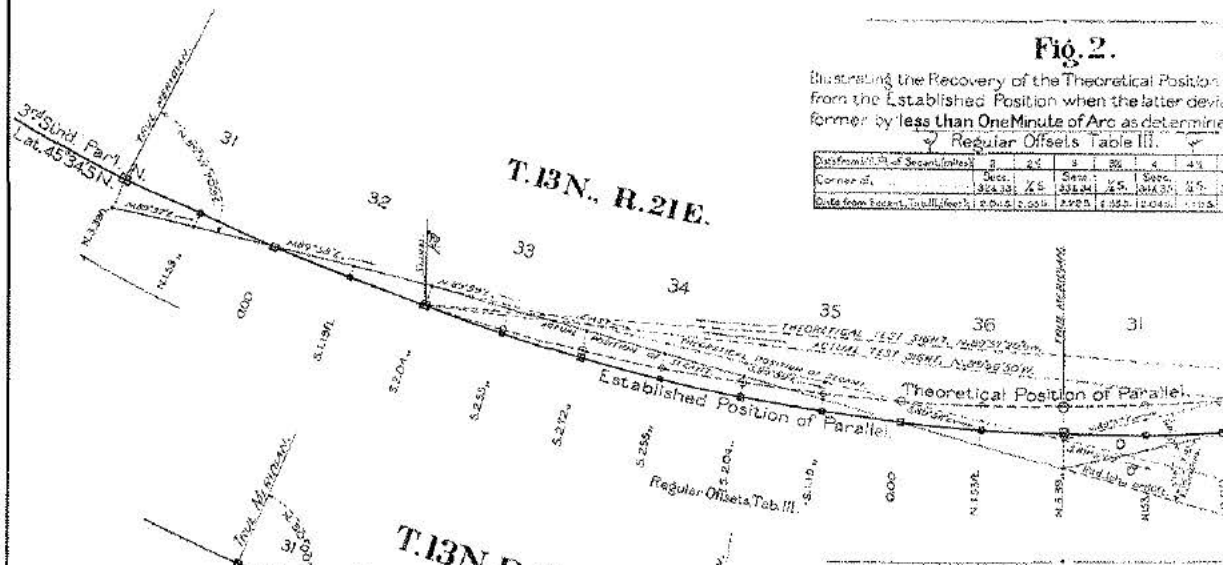

Fig. 3.

# TANGENT METHOD.

Fig. 1.

REGULAR METHOD.

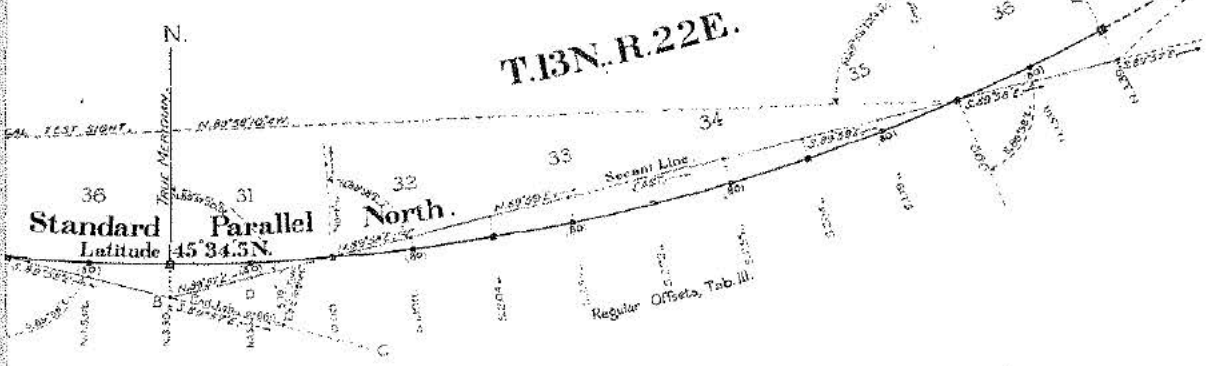

Fig. 2.

The Recovery of the Theoretical Position of the Parallel established Position when the latter deviates from the less than One Minute of Arc as determined by Platan's Obs. Regular Offsets Table III.

Section	1	2	3	4	5	6
Sec. 1	375.28	729	1083.4	1437.5	1791.6	2145.7
Tab. III (ft)	1.00416	2.00832	3.01248	4.01664	5.02080	6.02496

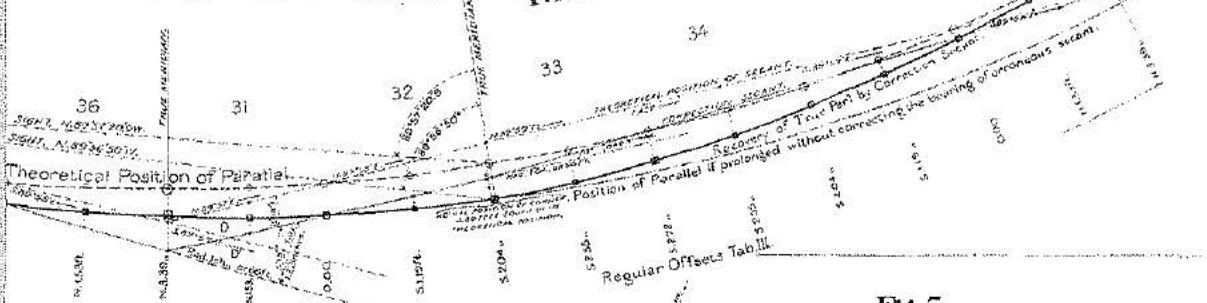
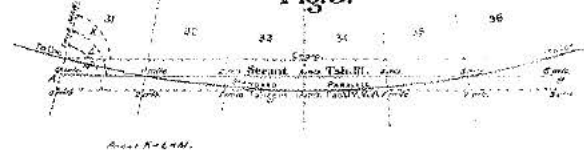

Fig. 5.



T. 13N., R. 24E.

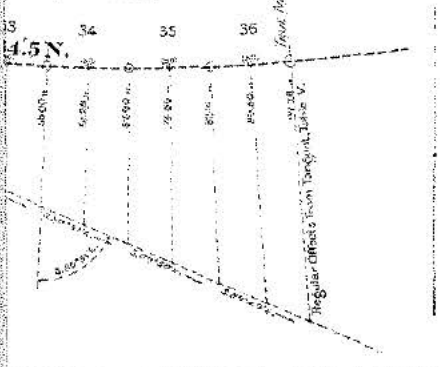
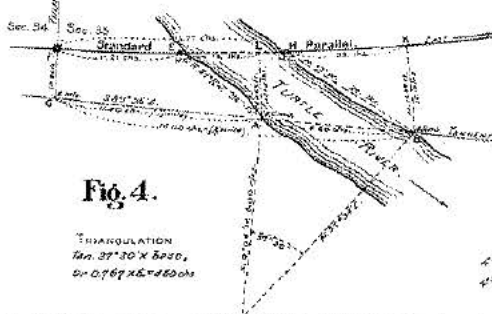

Fig. 4.



TRIANGULATION  
An. 37°30' X 5000,  
or 0.767 x 5000 = 3835

AL = diff. lat. of course AE;  
EL = departure of AE;  
whence, AG = FL;  
thence, EF = AG - EL;

HK = departure of BH,  
and, FH = GB - HK.

For the courses AL and BK:  
42° (42) : 10.86 : 11.657 = 11.64 m. = AL.  
42° (42) : 10.86 : 11.377 = 11.35 m. = BK.

# TOWNSHIP EXTENSION

Scale: 1 inch to 160 chains.

FOURTH STANDARD PARALLEL  
East

### Explanations.

— Old Surveys.

 Surveyed under current contract.

- - - - - Unsurveyed.

Table of Mileage.

Survey Designated.	Amount		When Surveyed.
	No.	Chs. Lhs.	
Standard lines	30	00	Aug. 22 to 30, 1880
Township	11	79	25, Sept. 5 to 13, 1880
Connecting			

FIFTH GUIDE MERIDIAN EAST.  
North

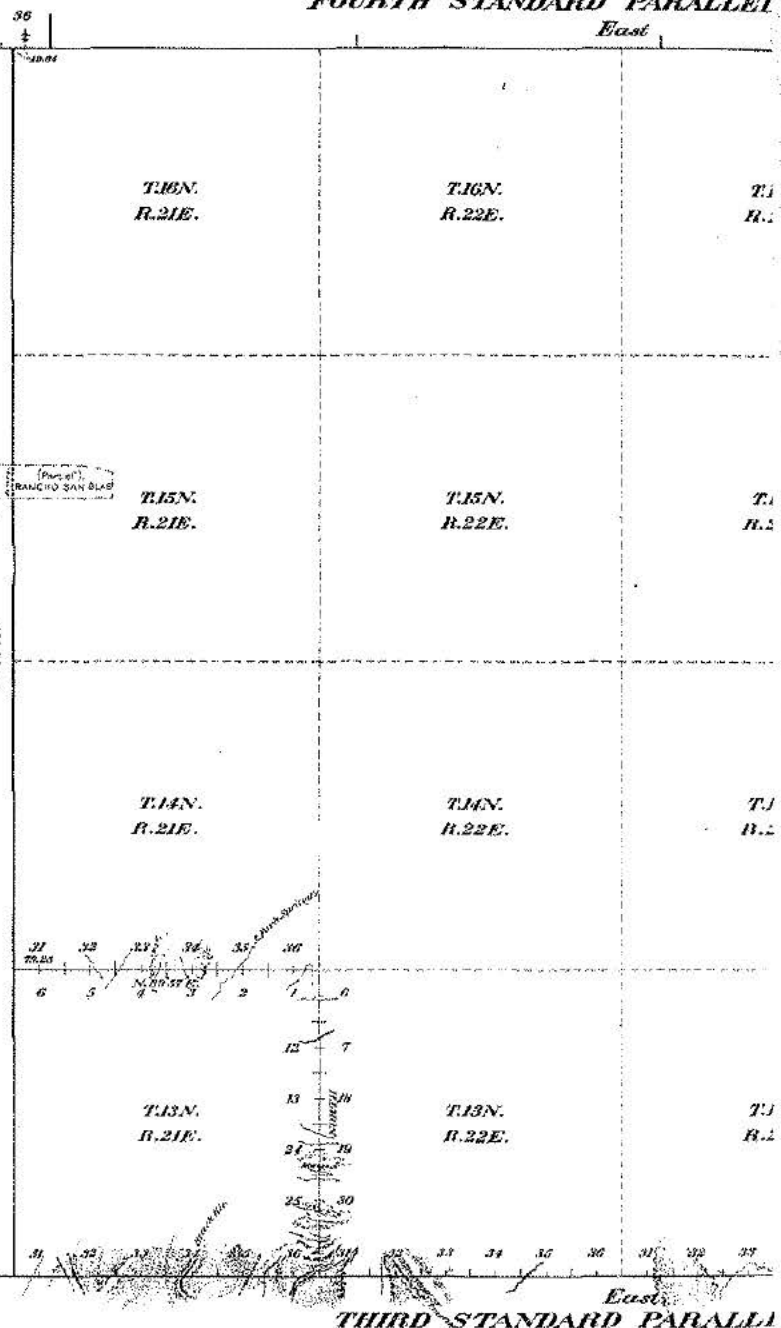

THIRD STANDARD PARALLEL  
East

SHIP EXTERIORS.

Scale: 1 inch to 160 chains.

STANDARD PARALLEL NORTH.

East

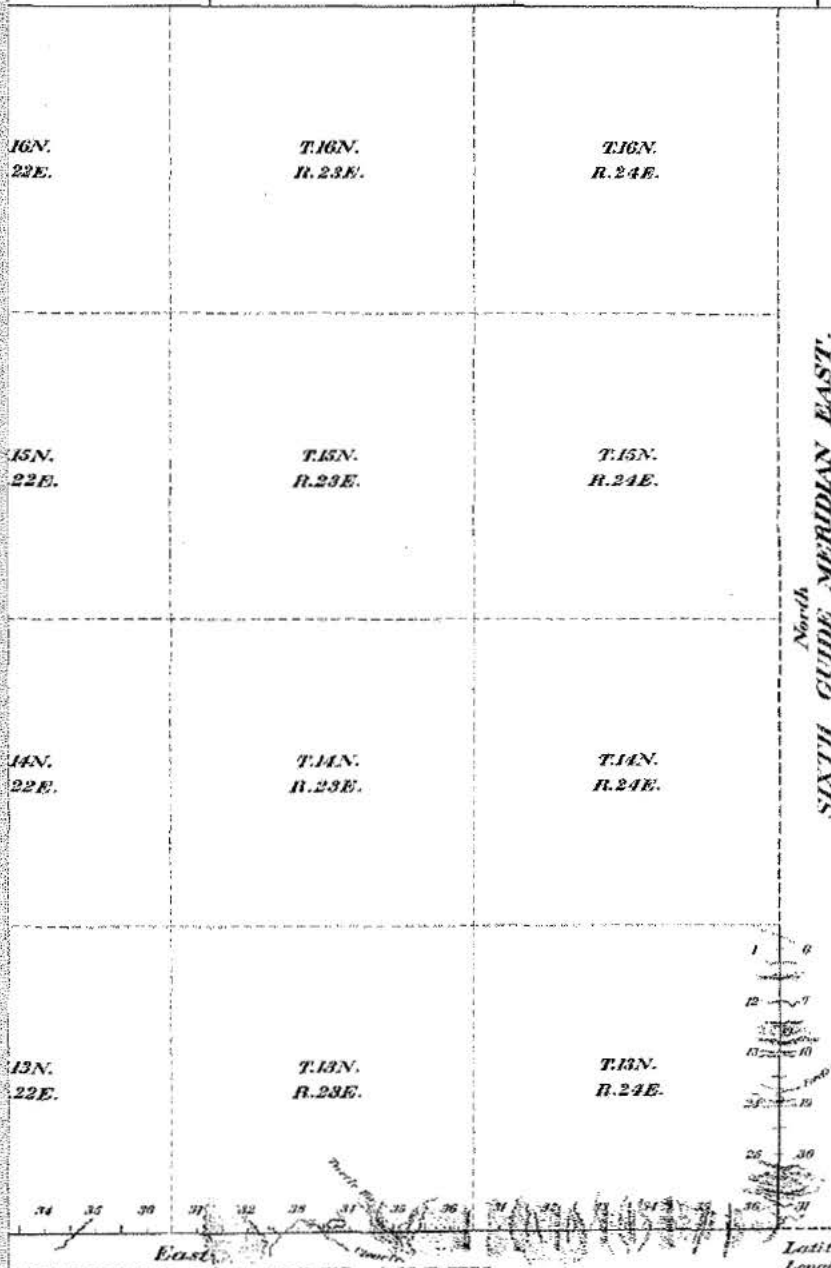

This Plat.  
of the  
3<sup>d</sup> Standard Parallel North  
through Ranges 21, 22, 23 & 24 E.;  
East Boundary of T. 13 N., R. 21 E.;  
North " " " "  
and the  
Sixth Guide Meridian East  
through Township 13 North,  
Montana Principal Meridian;  
is strictly conformable to the  
field notes of the survey thereof  
by  
Richard Hoods, U.S. Dep. Surv.,  
under his  
Contract No 97,  
dated July 10<sup>th</sup> 1890,  
which have been examined,  
approved and filed in this office  
West. Surv. Gen's Office.  
Helena, Montana.  
(Date of Approval.)  
West. Surv. Genl.

North  
SIXTH GUIDE MERIDIAN EAST.

Township N<sup>o</sup> 15 North, Range N<sup>o</sup> 20 East of the

G r F e E d D c

88956E.

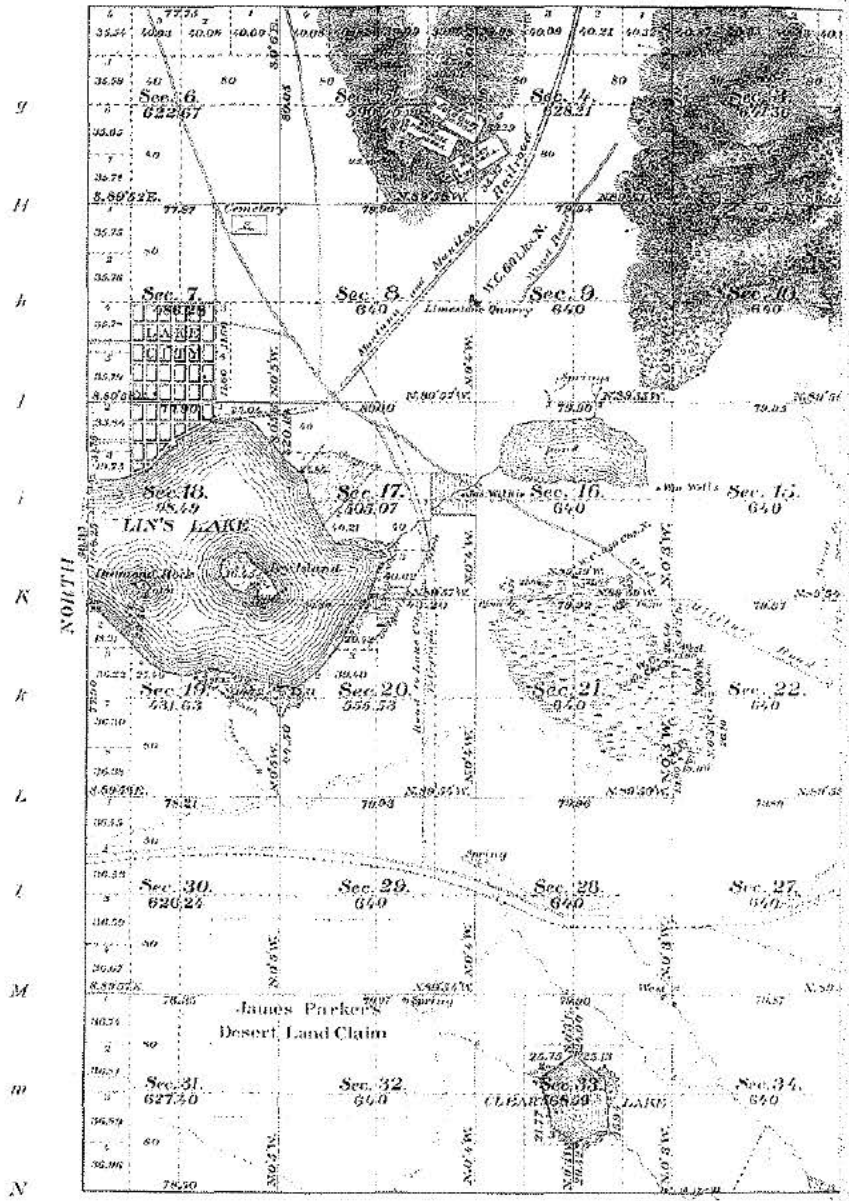

85037E.

Area in acres: Public Land, 20872.27, Townships 199.01, Private Land Claim, 432.80, Water surface, 1362.98, Mineral Claims, 61.98, Total Area, 22949.05 Acres.

Surveys Designated	By Whom Surveyed	No.	Contract Date	Amount of Surveys			When Surveyed
				Ac.	Chs.	Idcs.	
Subdivisions	Robert Aves	207	March 22 <sup>nd</sup> 1892	56	60	72	Aug. 4 <sup>th</sup> to 19 <sup>th</sup> 1893.
Connections	..	..	..	73	60	..	..
Abunders	..	..	..	12	19	26	..

Range No 20 East of the Principal Meridian Mont.

d D c C b B a A

88956E.

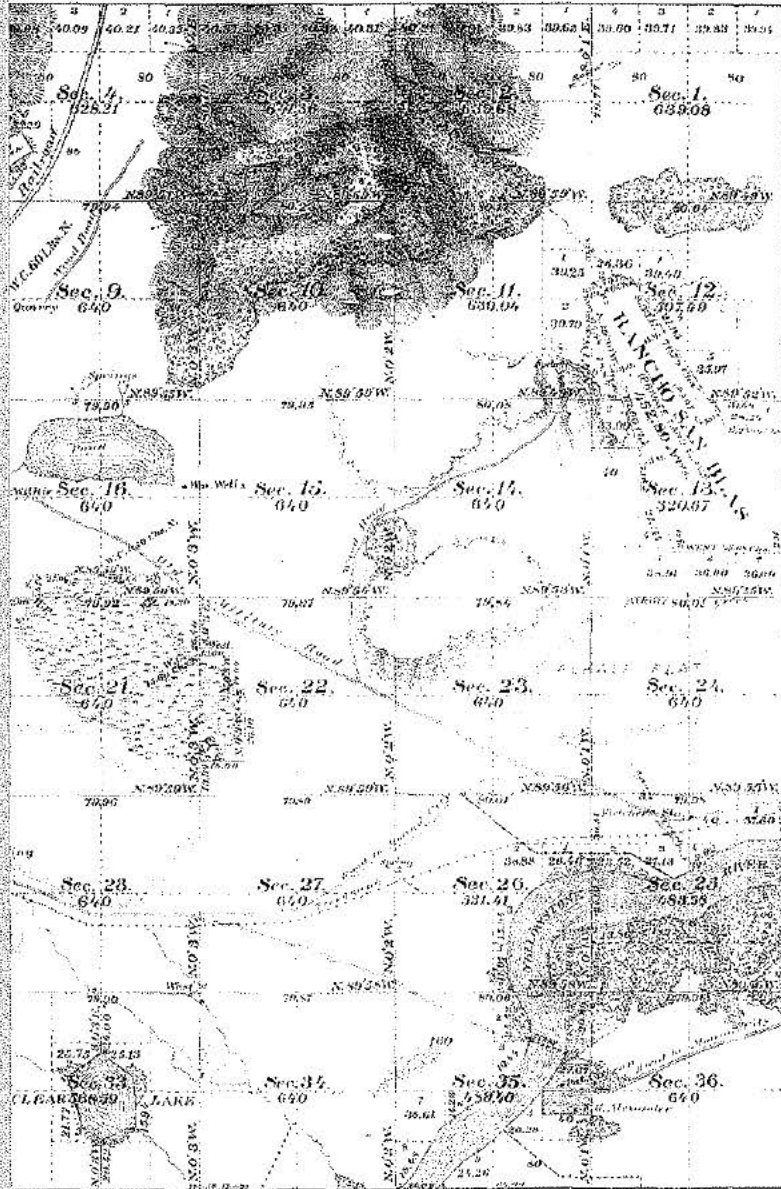

NORTH  
 FIFTH GUIDE MERIDIAN E  
 W  
 W  
 V  
 U  
 T  
 S  
 R  
 Q  
 P  
 TRUE MERIDIAN

Latitude 45° 45' N.  
 Longitude 107° 54' W.  
 Mean mag. Dec. 1870-1875

88957E.

p Q r

Private Land Claim 432.80.  
 Total Area 22949.05 Acres.

Amount of Surveys	When Surveyed
60 72	Aug. 5 <sup>th</sup> to 19 <sup>th</sup> 1893.
73 60	..
19 26	..

H r S s T

Scale of Chains to an Inch.

The above Map of Township No. 15 North of Range No. 20 East of the Principal Meridian, Montana is strictly conformable to the field notes of the survey thereof on file in this Office, which have been examined and approved.

Surveyor General's Office.

Geo. S. Bond

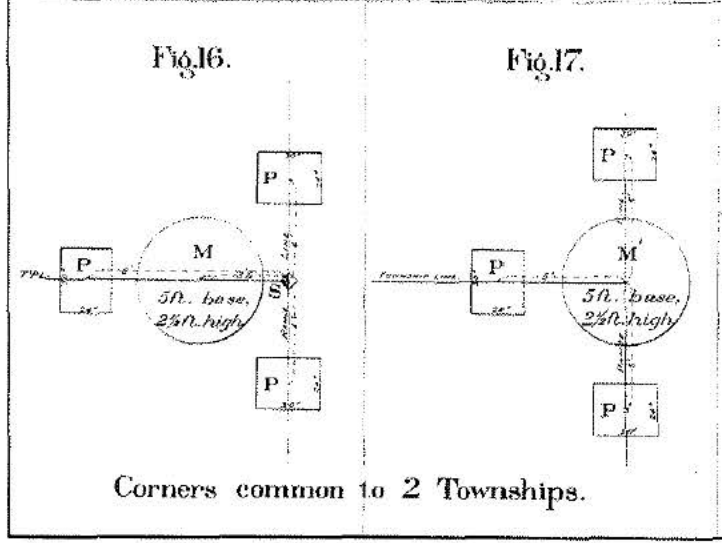
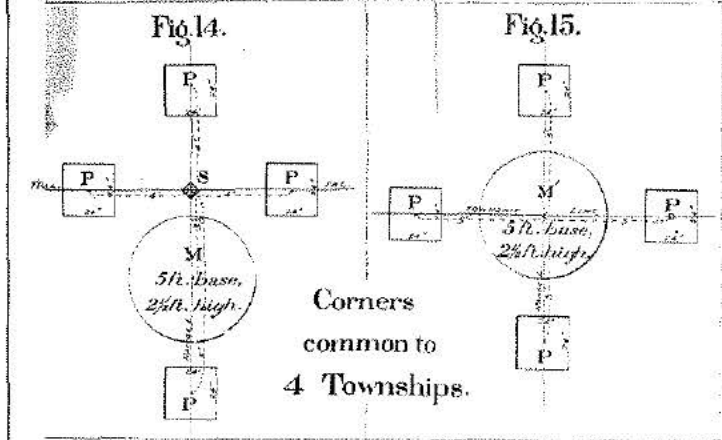
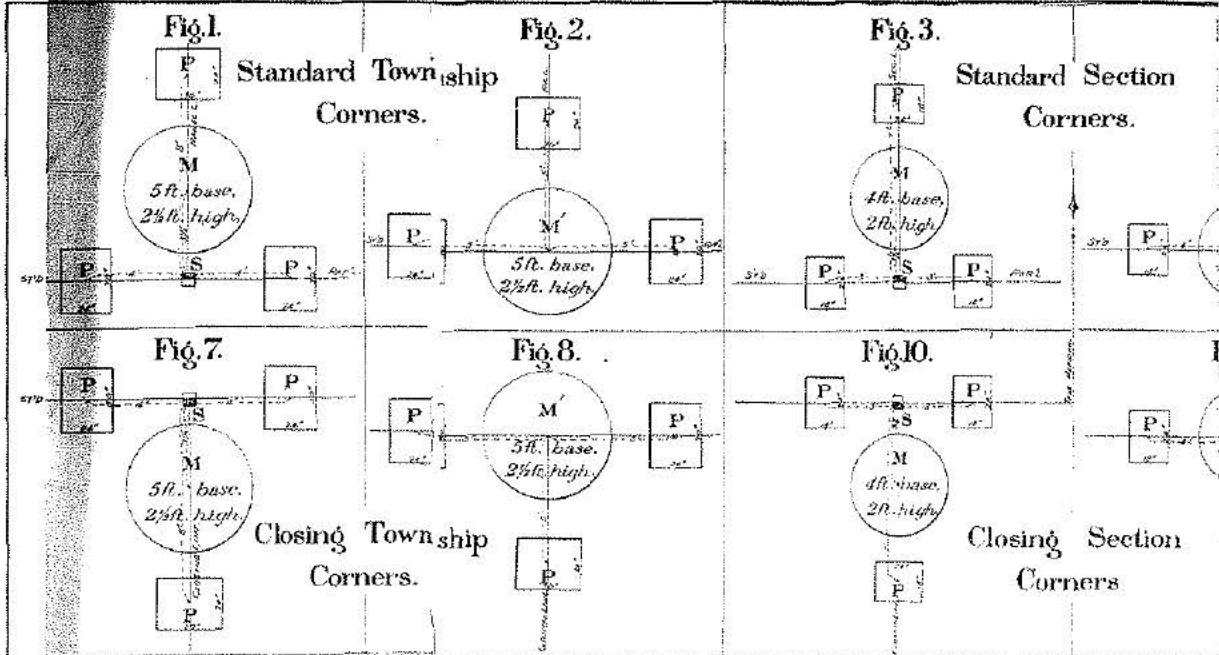

# PLANS OF CORNERS

Scale: 2 inch = 1 foot.

## EXPLANATIONS.

S. Corner Stone. M. Mound. M. Mound with 5 ft. base and 2 1/2 ft. high.

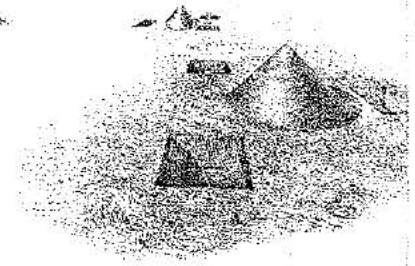

## PERSPECTIVE.

of Standard Tp Cor., with Closing Tp Cor. in

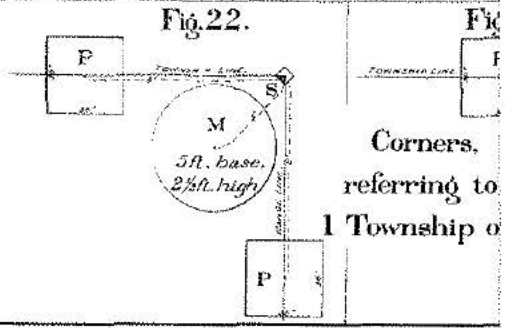

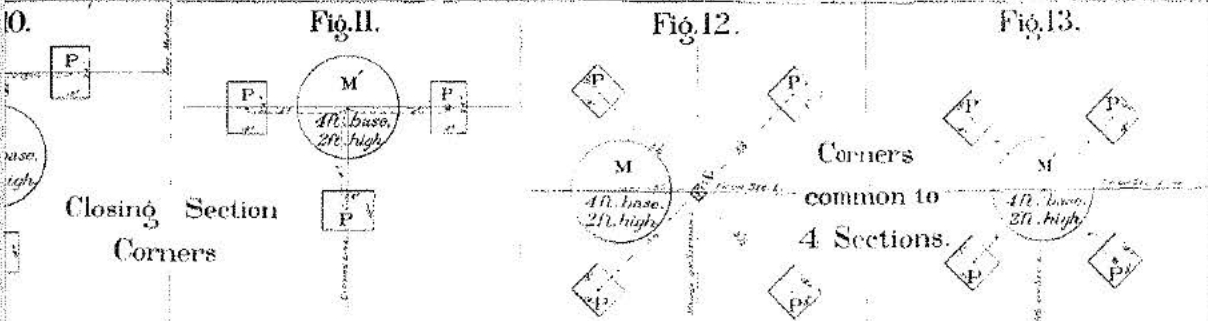
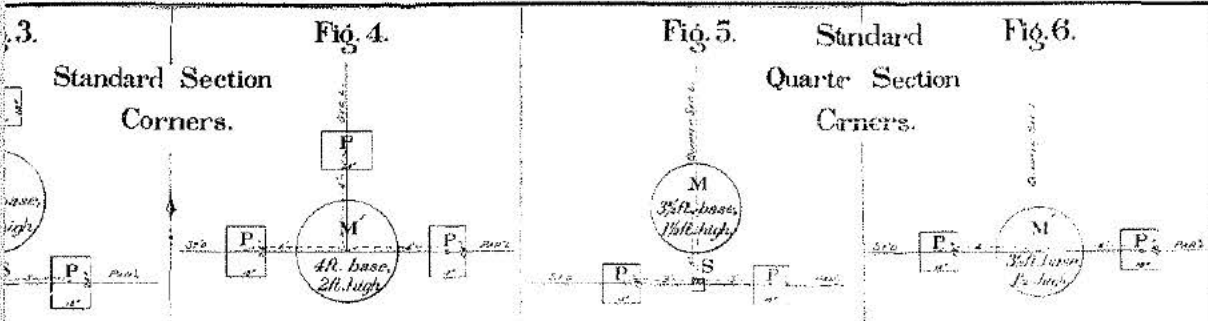

WAYS OF CORNERS.

Scale: 1/2 inch = 1 foot.  
 EXPLANATIONS.  
 Stone, M. Mound, M. Mound with deposit, P. Pt.  
 o Stake.

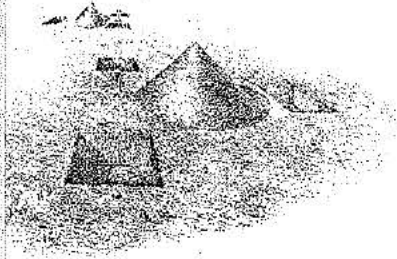

and Tp Cor., with Closing Tp Cor., in the distance.

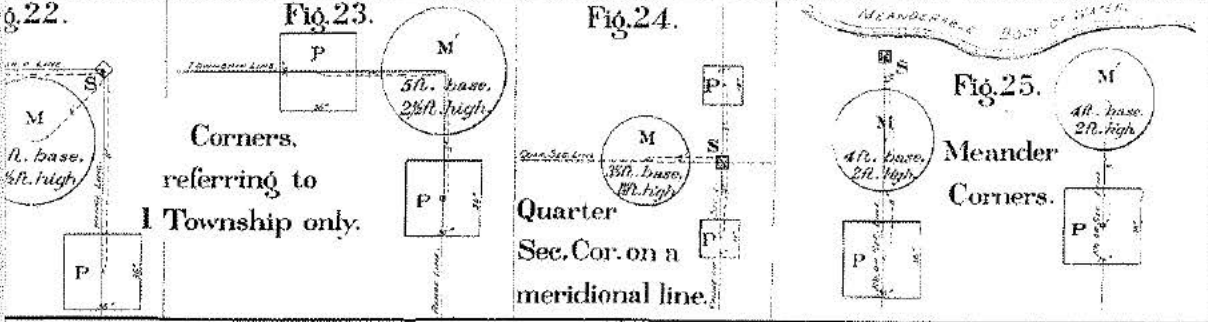
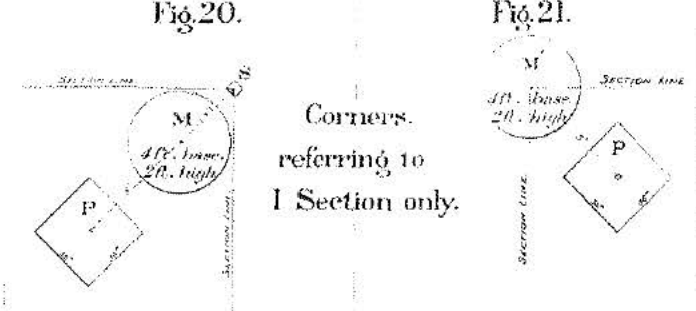
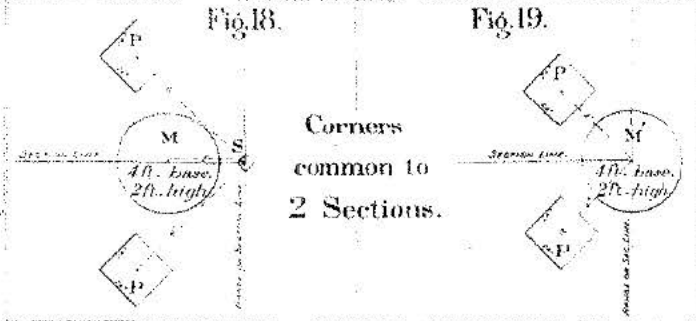





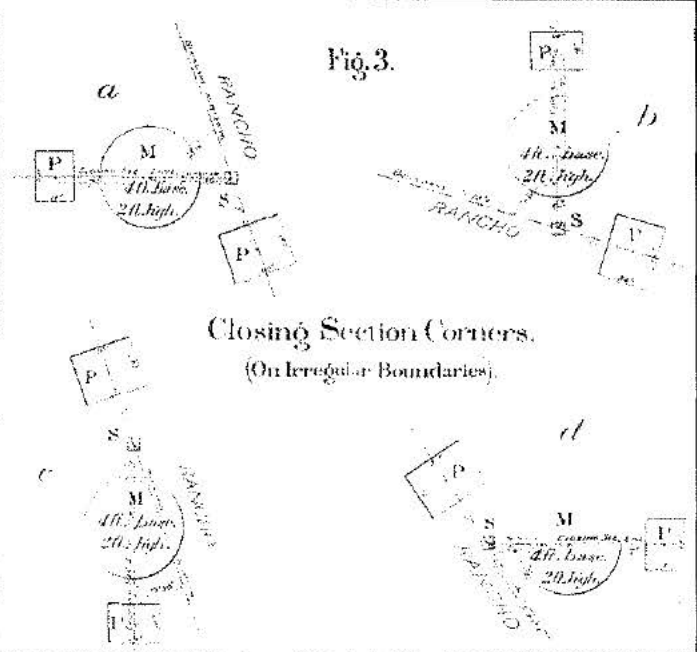
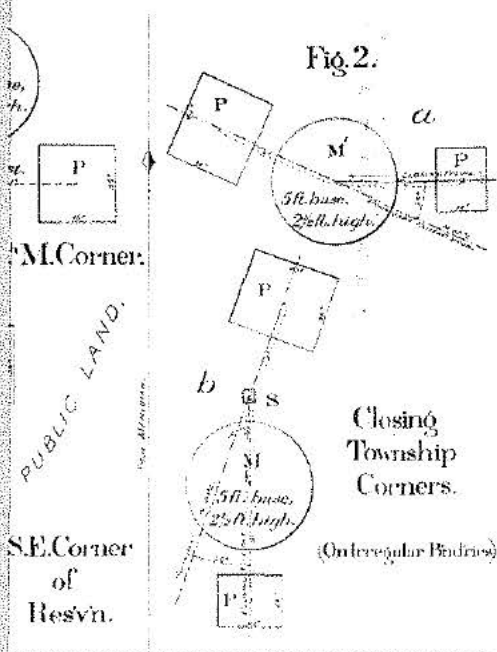

US OF CORNERS.

(Scale 1 inch = 1 foot.)  
 AND  
 Miscellaneous Diagrams.  
 EXPLANATIONS.  
 M.M. and M. found with deposit. P.P.P.  
 a Scale.

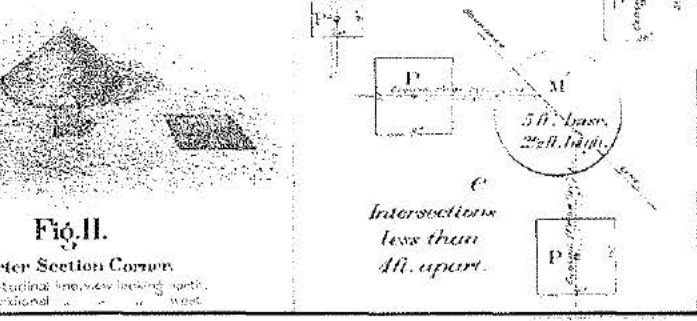
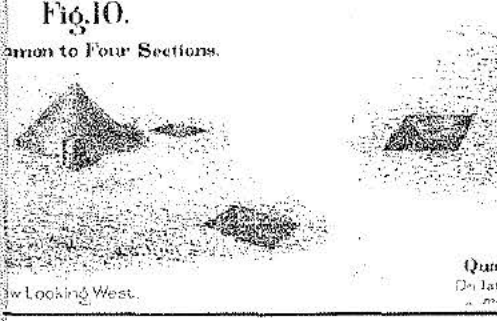
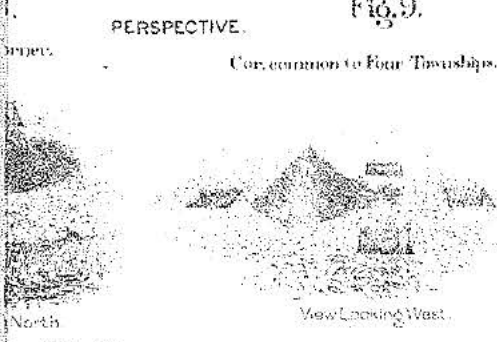
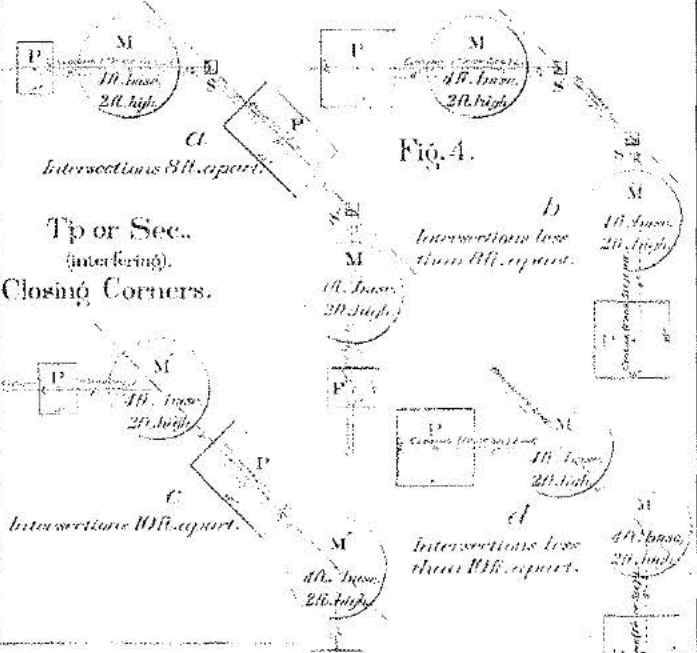









R.7W.

R.6W.

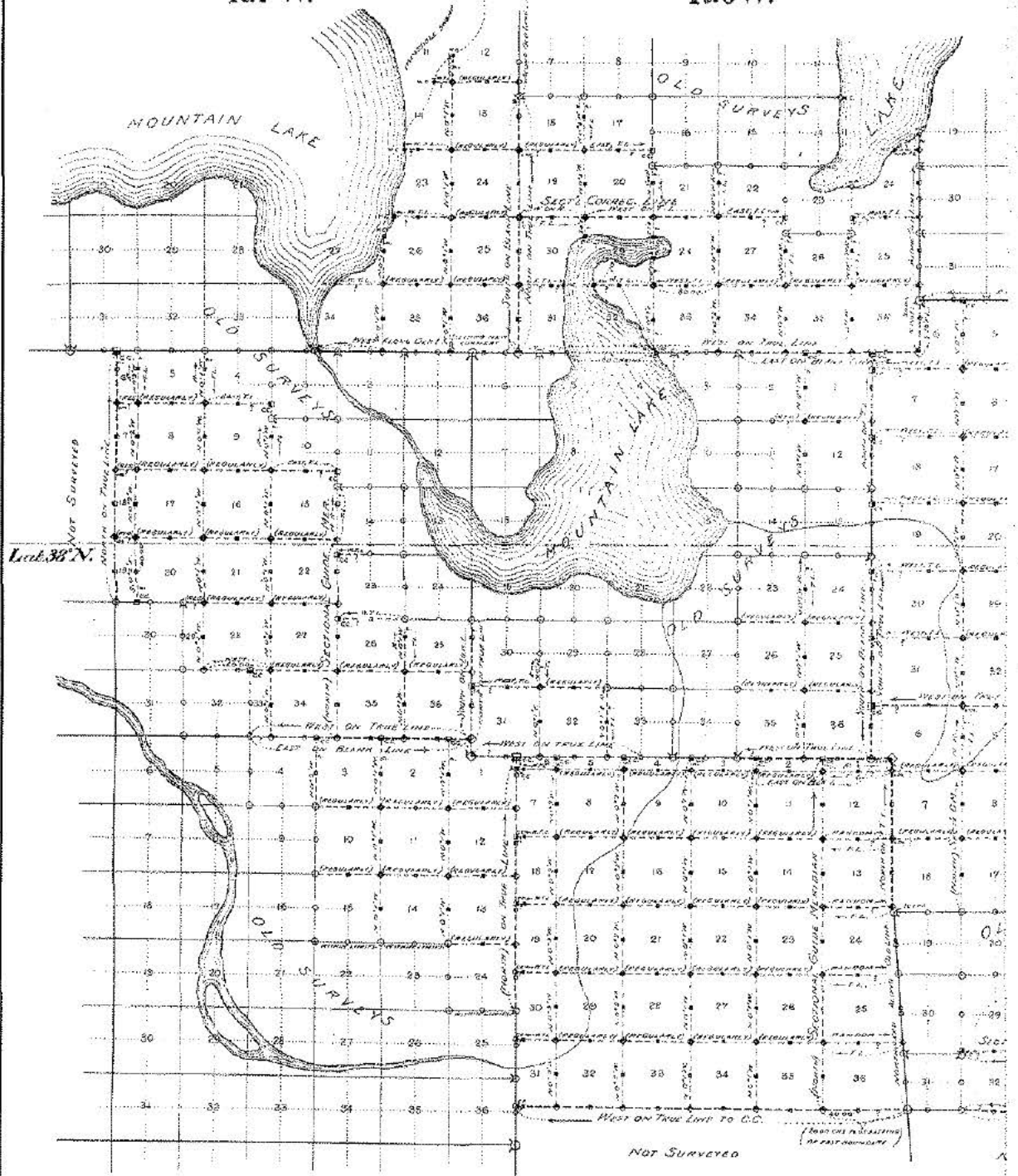

R.7W.

R.6W.

